

ASSEMBLY INSTRUCTION

DESCRIPTION M7TE9 FROG TRAMPOLINE

30 minutes

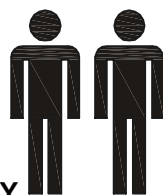

FLOOR AREA
1.5M×1.5M×2M

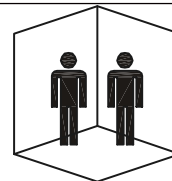

APPROXIMATE ASSEMBLY TIME

2 PERSON ASSEMBLY

REQUIRED ASSEMBLY SPACE

PRODUCT WEIGHT 2.5KG, BUILD IN LOCATION

REQUIRED ASSEMBLY TOOL

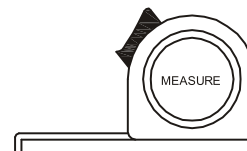

ASSEMBLED DIMENSIONS

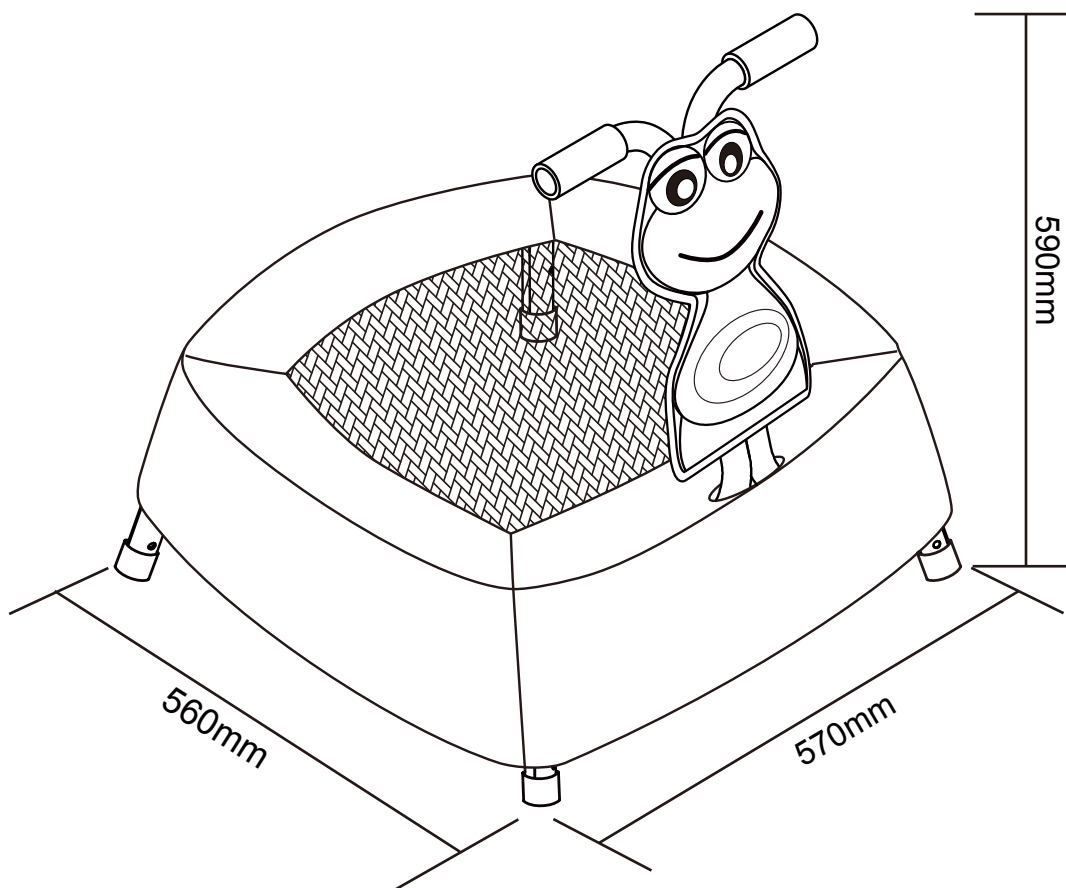







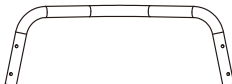
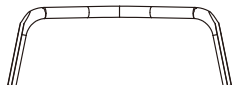

SPORTSPOWER™

20/F, Parkview Centre, 7 Lau Li Street, Causeway Bay, Hong Kong.
After Service Centre (+44) 0330 0904 420, Email support@sportspowerfit4kids.com or
visit www.sportspowerfit4kids.com

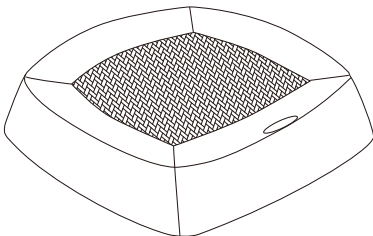
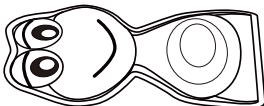
ASSEMBLY INSTRUCTION

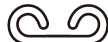



DESCRIPTION M7TE9 FROG TRAMPOLINE

Part No.	Description	Picture	QTY
(1)	U-LEG		1 VIEW PRODUCT
(2)	U-LEG		2 VIEW PRODUCT
(3)	S-LEG		1 VIEW PRODUCT
(4)	S-LEG		1 VIEW PRODUCT
(5)	HANDLE ARCH		2 VIEW PRODUCT
(6)	MAT WITH PAD		1 VIEW PRODUCT
(7)	FROG COVER		1 VIEW PRODUCT
(8)	ELASTIC CORD		1 VIEW PRODUCT
(9)	HOOK		1 VIEW PRODUCT
(10)	PLASTIC TUBE		1 VIEW PRODUCT
(11)	LEG CAP		4 VIEW PRODUCT

ASSEMBLY INSTRUCTION

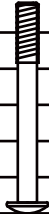
DESCRIPTION M7TE9 FROG TRAMPOLINE

HARDWARE LIST

					13cm
					12cm
					11cm
					10cm
					9cm
					8cm
					7cm
					6cm
					5cm
					4cm
					3cm
					2cm
					1cm
					0cm
					
8x M6 x 38mm	2x M6 x 58mm	20x Φ6.5 x Φ13	10x Φ6.5 x Φ13	10x M6	
A	B	C	D	E	
Short Bolt	Bolt	Flat Washer	Spring Washer	Cap Nut	
VIEW PRODUCT	VIEW PRODUCT	VIEW PRODUCT	VIEW PRODUCT	VIEW PRODUCT	

TOOLS

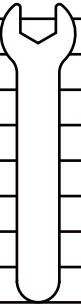
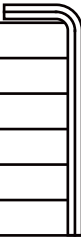
		11cm
		10cm
		9cm
		8cm
		7cm
		6cm
		5cm
		4cm
		3cm
		2cm
		1cm
		0cm
		
1x M6	1x 4mm	
W	Z	
Spanner	Allen Key	
VIEW PRODUCT	VIEW PRODUCT	

For faulty or missing parts please contact customer services: call (+44) 0330 0904 420, Email support@sportspowerfit4kids.com or visit www.sportspowerfit4kids.com

ASSEMBLY INSTRUCTION

DESCRIPTION M7TE9 FROG TRAMPOLINE

Top Tips before you start

1. Please check that all parts are in the package before you start the assembly of your product. Once assembled, the product is exempt from our home approval policy. **IF ANY PARTS ARE MISSING, PLEASE CALL +44 0330 0904 420.**
2. Please ensure that you have sufficient space and number of people required (as indicated on page 1) to assemble your product.
3. During assembly, please take care not to over-tighten any fittings, as this may damage the product. Once the product is fully assembled, check the entire unit to ensure all parts are securely fastened before allowing children to use.
4. Please retain these instructions for future reference.

Warnings

- This product is designed for use children ages 18 to 36 months old.
- The max user weight is 20kg.
- Adult supervision required.
- Not suitable for children under the age of 18 months. Small parts and long cords can cause choking and entanglement / strangulation hazards.
- Only one user at a time to avoid collision hazard.
- Only for domestic use.
- Only for indoor use.
- No somersaults or flips.
- Do not eat while jumping.
- Do not exit by a jump.
- Do not use the mat when it is wet. Properly store away to avoid injury or property damage.
- Empty pockets and hands before practice.
- Always jump in the middle of the mat.
- Properly step on and off the mat. Do not jump.
- Limit the time of continuous usage (make regular stops).
- DO NOT allow children to play on this product until it is completely installed.
- DO NOT attach items to the equipment that are not specifically designed for use with this product, such as but not limited to cables, skipping ropes and chains as they may cause strangulation hazards.
- Dress children appropriately while on and around this product. Use well-fitting shoes that do not have slippery soles. DO NOT allow children to wear ponchos, scarves, hoods, jewelry, loose shoes, loose fitting clothing, neckties, clothing with loose strings and / or clothing that might be potentially hazardous while using this product.

ASSEMBLY INSTRUCTIONS

- Before assembly, read and follow these step by step assembly instruction and warnings thoroughly. Failure to do so could result in serious injury or property damage.
- DO NOT attempt to assemble this product without following the instructions carefully.
- This product must be placed on a level surface and at least 2 meters from any structure that could cause injury.
- Only adults should assemble or disassemble this product as it may contain sharp points and small parts. Keep all components out of children's reach. Small parts pose a choking hazard to children less than 3 years old.

TIGHTENING NUTS AND BOLTS

- At the start of assembling, DO NOT FULLY tighten bolts / nuts all the way so as to allow some possible adjustment for ease of assembly.
- DO NOT use pliers or power tools to tighten up screws as they can cause damage to paintwork and nuts and bolts.
- After all major components are assembled, go back over all bolts and nuts and properly tighten all before using the product.

CARE AND MAINTENANCE INSTRUCTIONS

- Carry out checks and maintenance of the main frame parts, mat, cord, nuts and bolts before each play session and at least every two weeks.
- Check all nuts, bolts and fittings for tightness and re-tighten if required.
- Check unit for sharp edges which may have occurred during shipping, assembly, abuse or everyday usage. Replace if required.
- Check frame for any evidence of deterioration, cracks or exposed edges which could cause injury. If there are any such problems, contact the **HELP LINE: +44 0330 0904 420** for replacement parts.
- When you wish to disassemble or dispose of the product, please completely disassemble the unit and discard of it in a safe place and manner so as not to present any hazard to any individual.

ASSEMBLY INSTRUCTION

DESCRIPTION M7TE9 FROG TRAMPOLINE

Step 1

Remove all parts from the packaging and lay the frame out in a large open space.

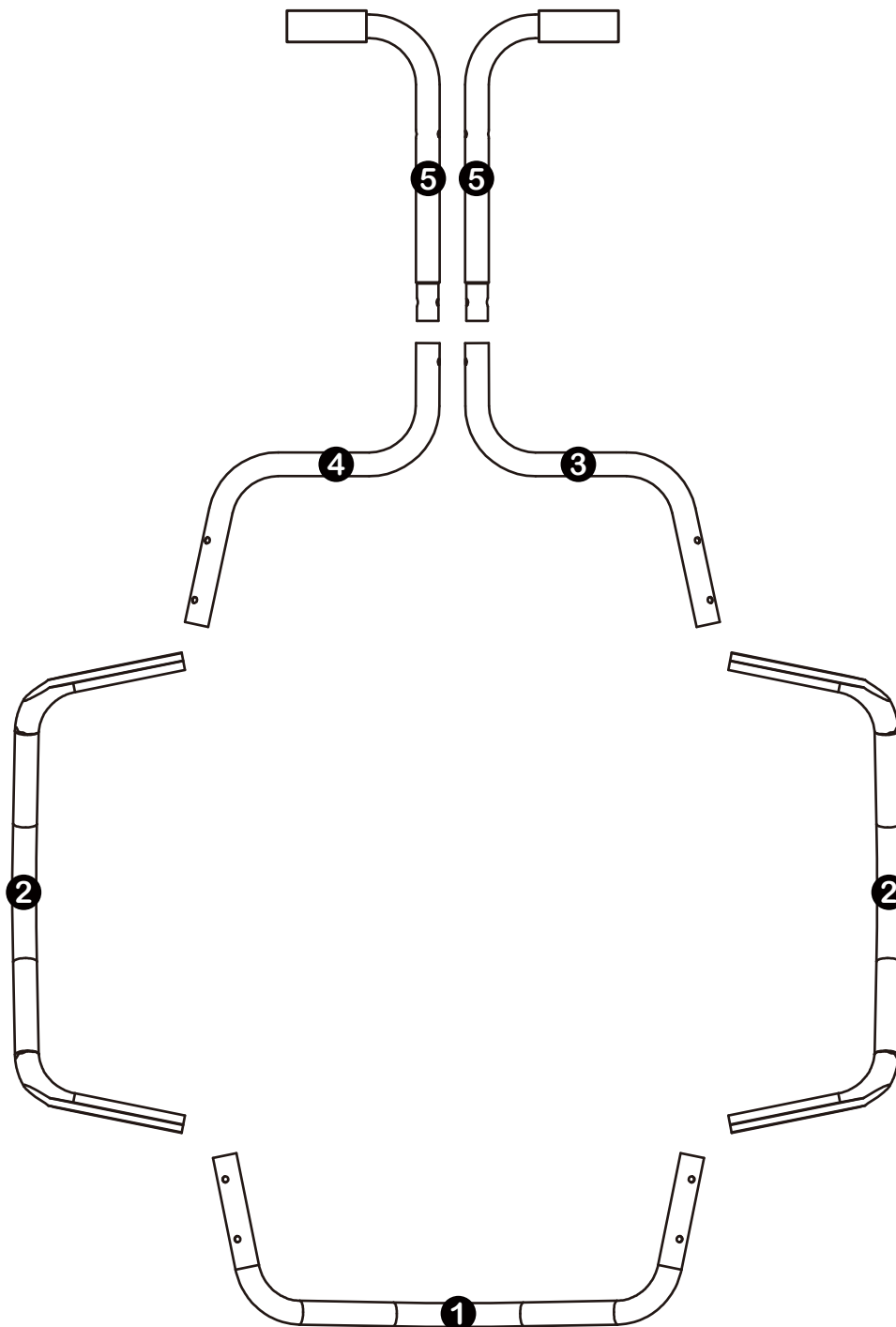





ASSEMBLY INSTRUCTION

DESCRIPTION M7TE9 FROG TRAMPOLINE

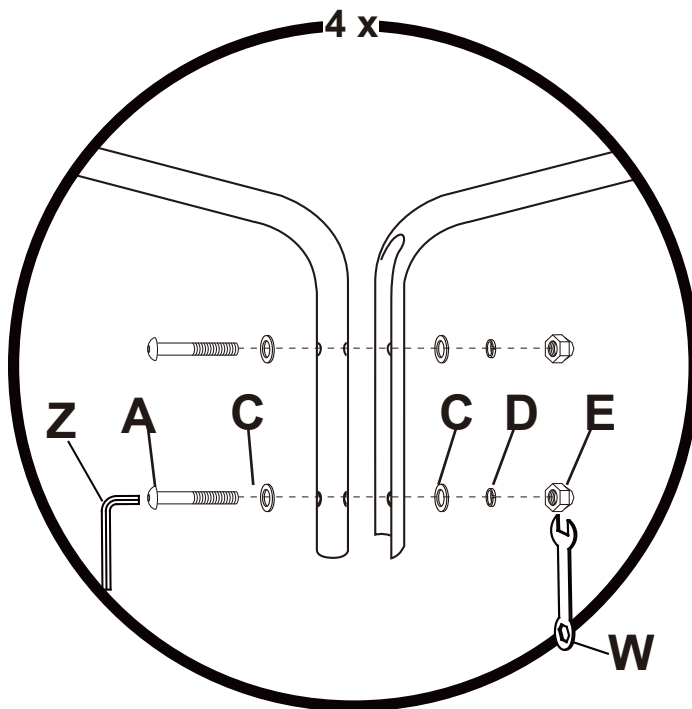
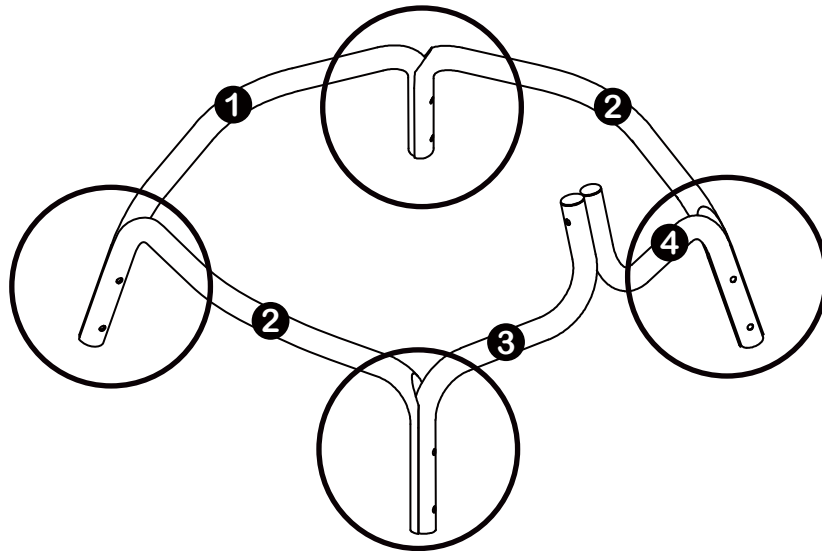
Step 2

Attach all legs as shown below.



			
A	C	D	E
x 8pcs	x 16pcs	x 8pcs	x 8pcs

ASSEMBLY INSTRUCTION

DESCRIPTION M7TE9 FROG TRAMPOLINE

Step 3

Place mat onto the assembled leg frame.

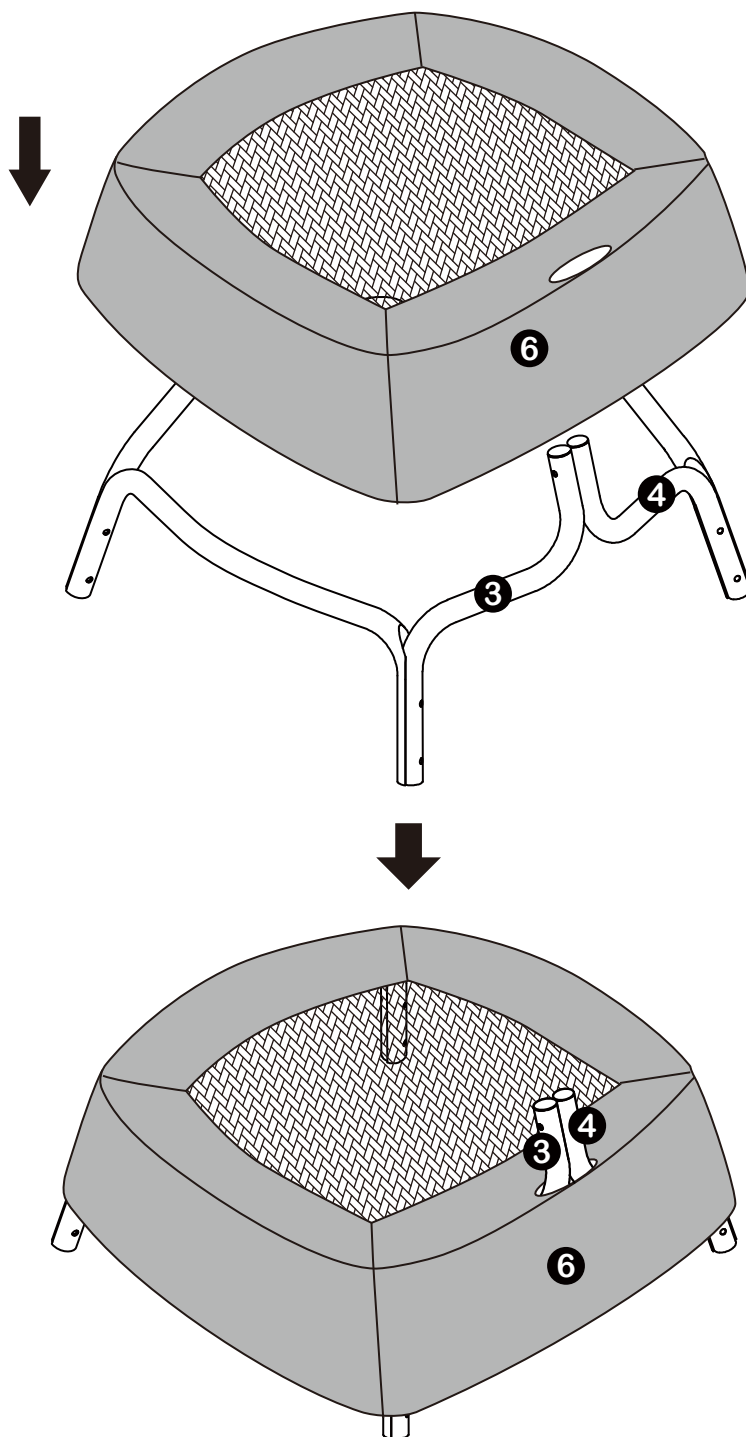





ASSEMBLY INSTRUCTION

DESCRIPTION M7TE9 FROG TRAMPOLINE

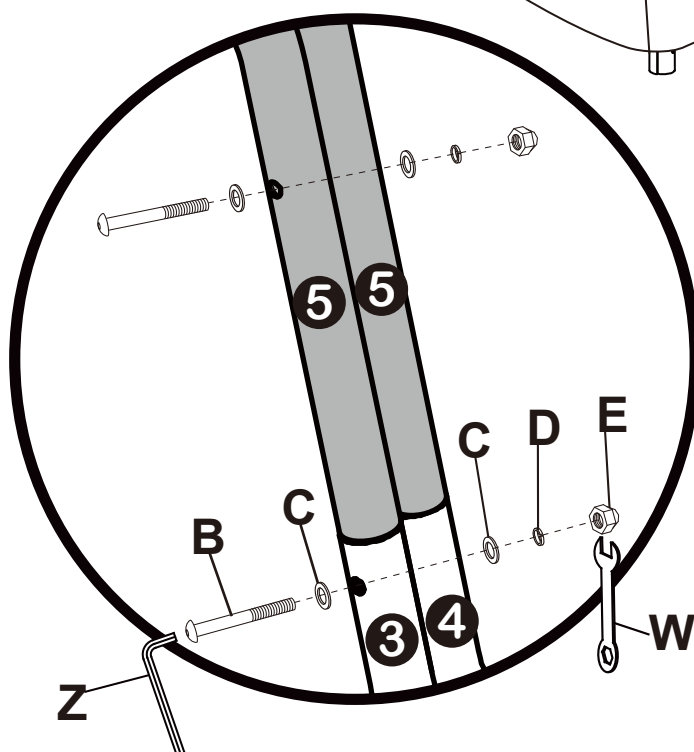
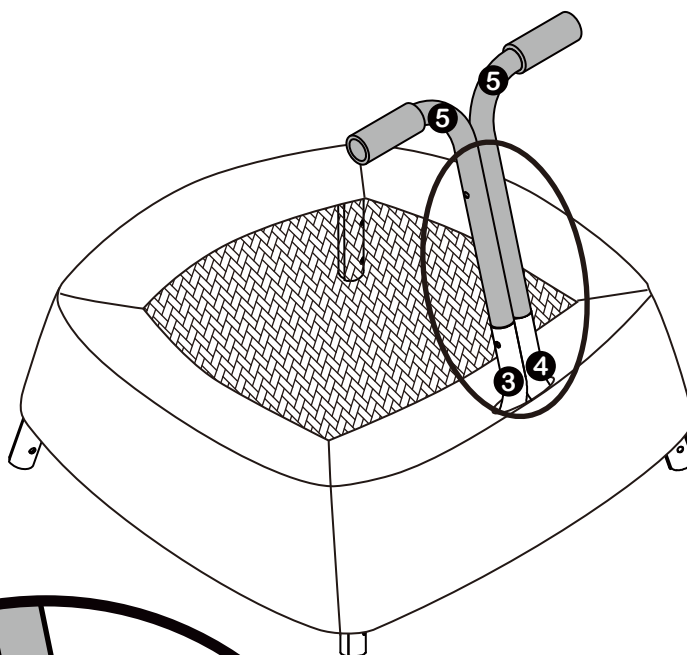
Step 4

Attach handle arch (5) to S-legs (3 and 4) as shown.



			
B	C	D	E
x 2pcs	x 4pcs	x 2pcs	x 2pcs

ASSEMBLY INSTRUCTION

DESCRIPTION M7TE9 FROG TRAMPOLINE

Step 5

Position the mat (6) in the centre of the frame and fold up the edges of the mat. Ensure the side with stitching is faced down. Starting at one corner, wrap the elastic cord (8) around the legs and up through the two straps as shown, ensuring that the length of the elastic cord is equal on both sides. Thread the elastic cord all the way around the trampoline as shown.

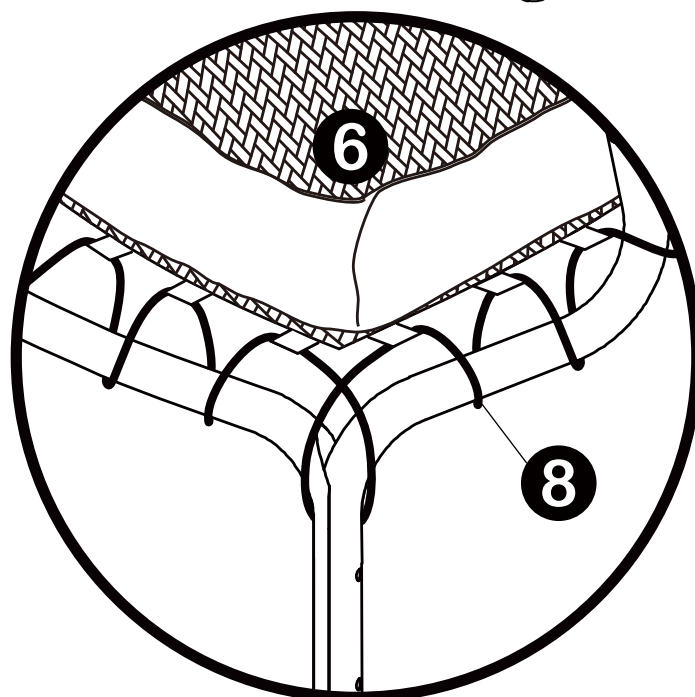
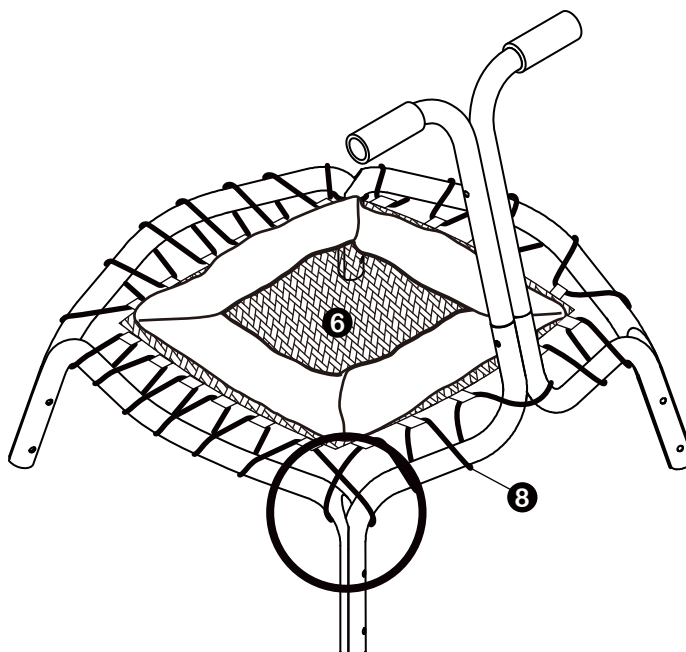

ASSEMBLY INSTRUCTION

DESCRIPTION M7TE9 FROG TRAMPOLINE

Step 6

Once the elastic cord has been fully wrapped around the mat and frame, attach the plastic tube (10) and the hook (9) to the ends of the elastic cord as shown. Hook the elastic ends together and slide the plastic tube (10) over the hook to cover it completely. Please take care when hooking the elastic cord around the final leg frame as the tension of the elastic cord at this point will be high.

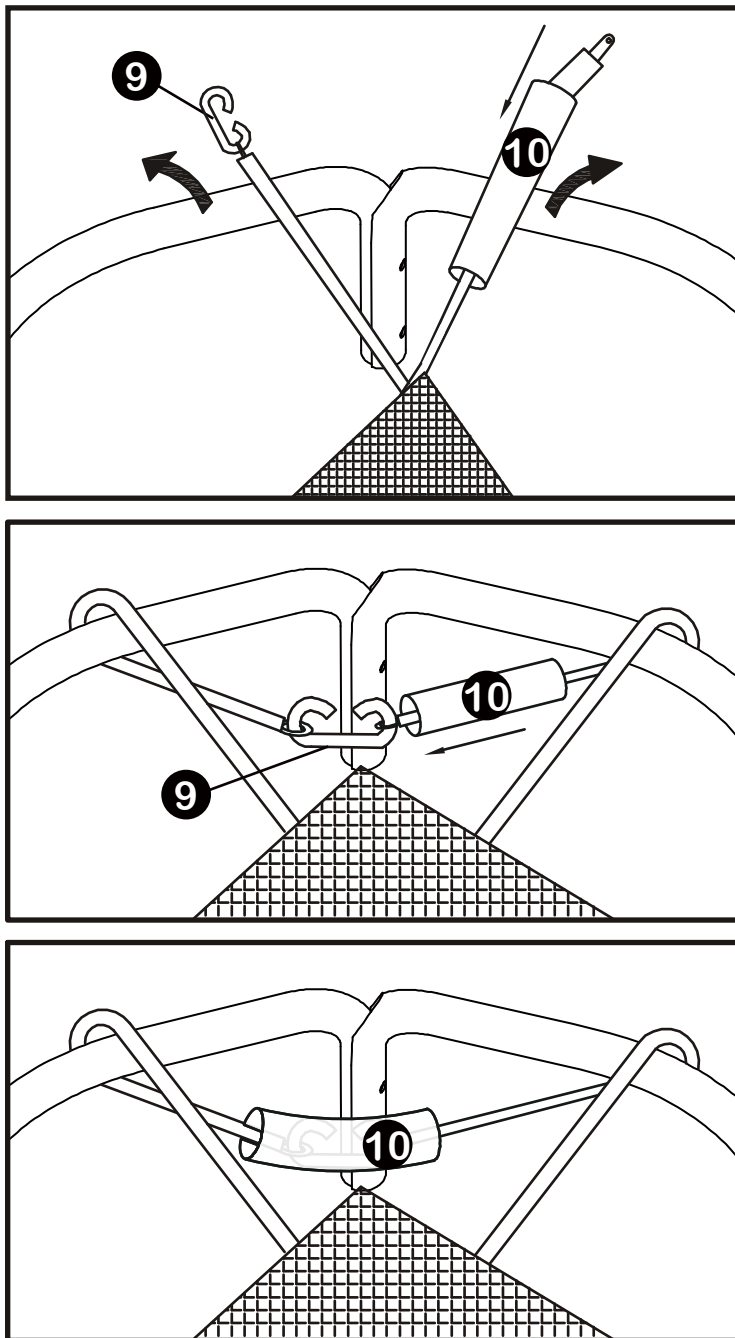

ASSEMBLY INSTRUCTION

DESCRIPTION M7TE9 FROG TRAMPOLINE

Step 7

The trampoline mat and frame may need to be re-centered and re-aligned upon hooking the elastic around the trampoline legs due to high tension in the elastic cord. Please ensure that the gap between the mat and frame is equal on all four sides. This is carried out by loosening or tightening each loop where appropriate and ensuring that the elastic cord and hook remains on the underside of the frame.

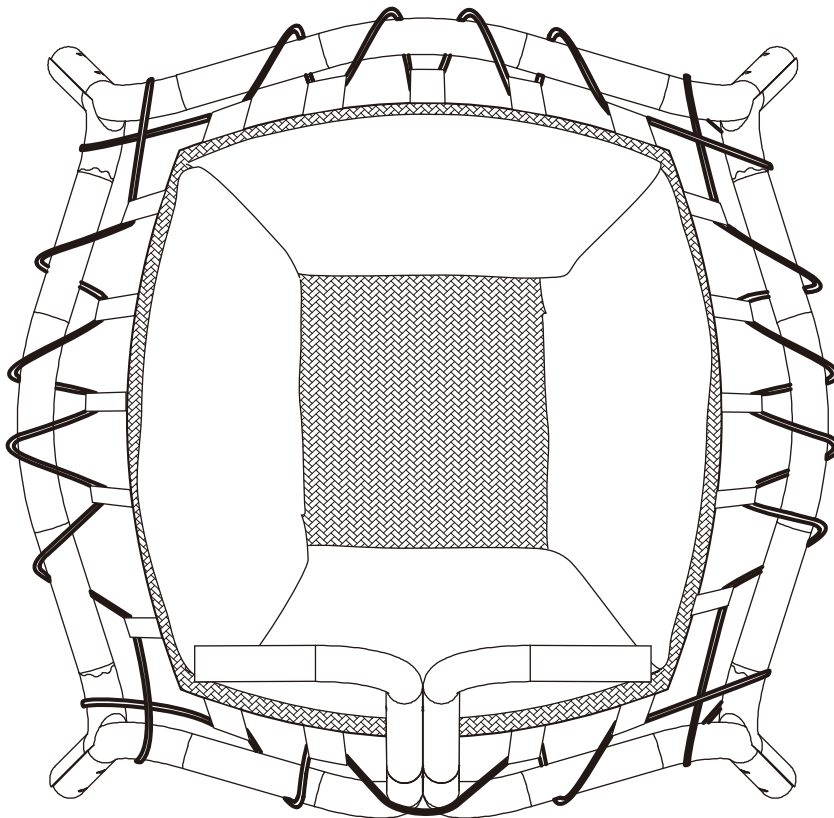

ASSEMBLY INSTRUCTION

DESCRIPTION M7TE9 FROG TRAMPOLINE

Step 8

Attach the end cap (11) onto the legs.

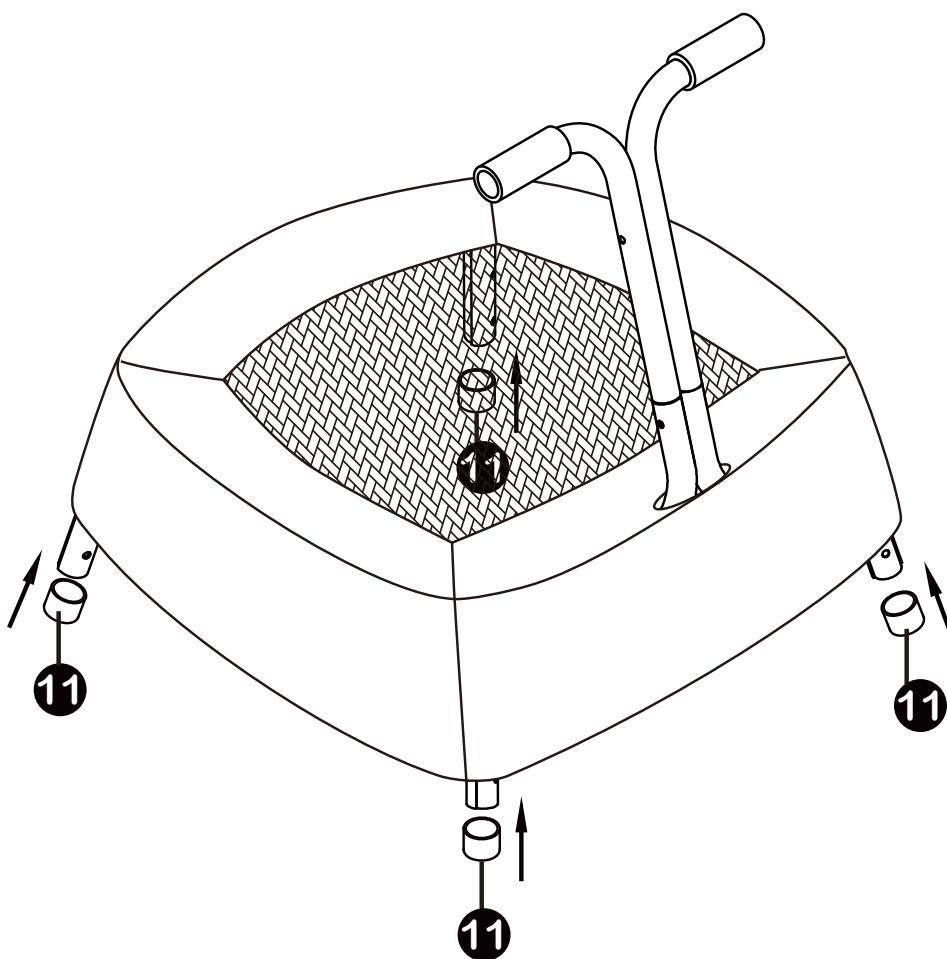

ASSEMBLY INSTRUCTION

DESCRIPTION M7TE9 FROG TRAMPOLINE

Step 9

If the trampoline is not entirely straight after assembly, lift up the leg on one side and press down on the frame until it is straightened.

Re-check all the screws to make sure they are securely fastened before use.

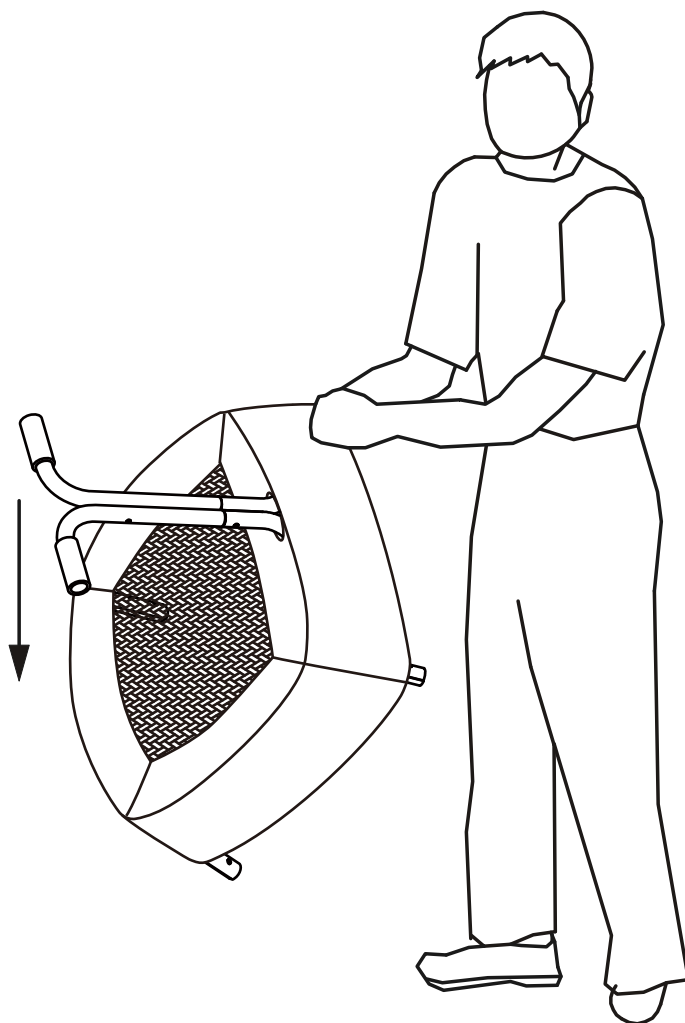

ASSEMBLY INSTRUCTION

DESCRIPTION M7TE9 FROG TRAMPOLINE

Step 10

Attach the frog cover (7) to the handle arches.

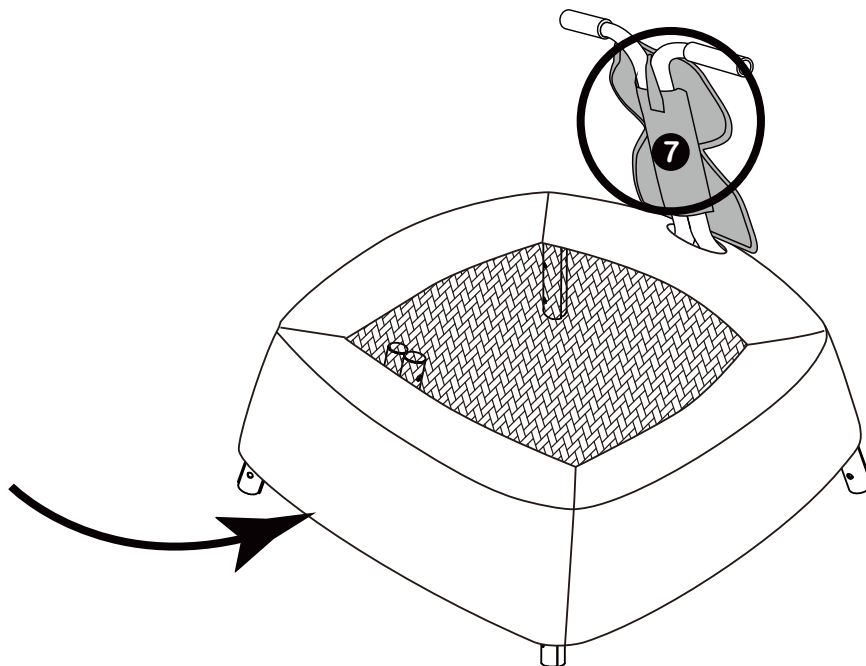
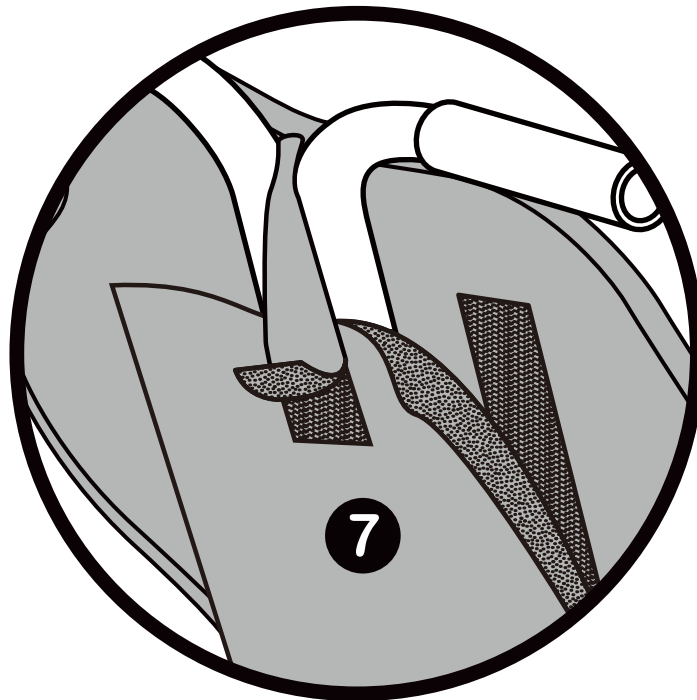

ASSEMBLY INSTRUCTION

DESCRIPTION M7TE9 FROG TRAMPOLINE

Finished Product

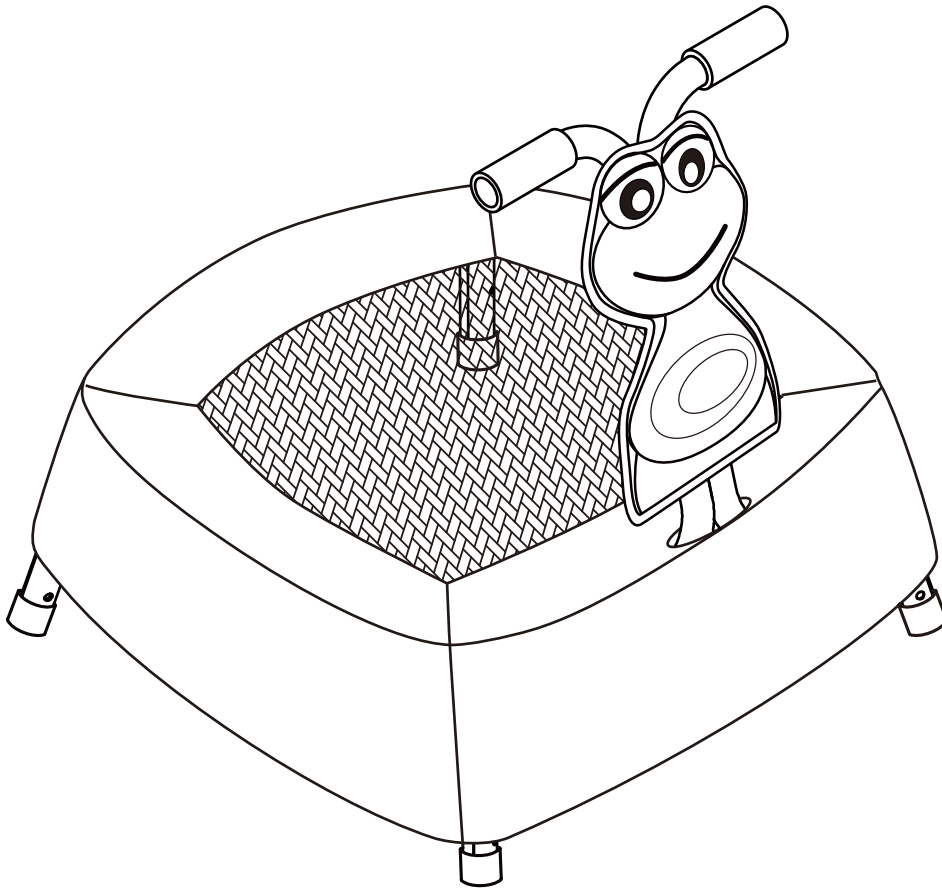

SP-19-TR-1023-SD-18001

SPORTSPOWER™

20/F, Parkview Centre, 7 Lau Li Street, Causeway Bay, Hong Kong.
After Service Centre (+44) 0330 0904 420, Email support@sportspowerfit4kids.com or
visit www.sportspowerfit4kids.com