

# DOUBLE SWING, GLIDE AND SLIDE

## USER AND ASSEMBLY MANUAL

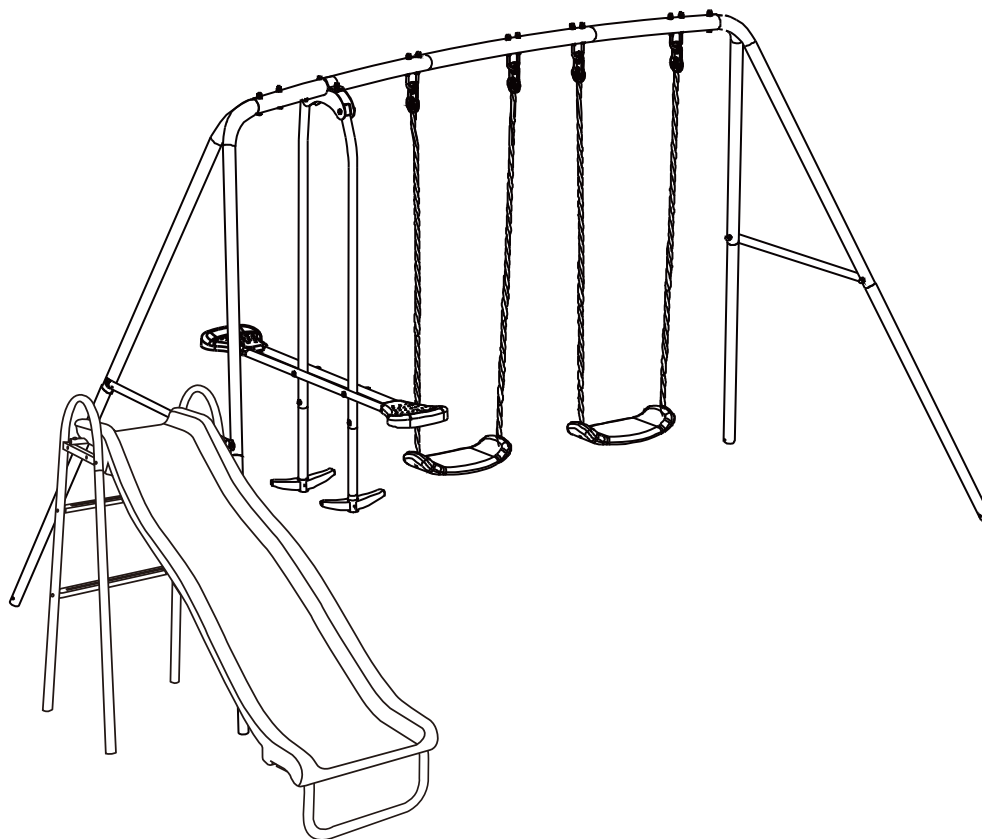

Tips : It will take 2 people around 60 mins to assemble this product.



### WARNINGS!



- Misuse and abuse of this product can result in injury.
- Read instructions before assembly or using this product. Retain Instructions.
- Always inspect product before use, checking for worn, defective or missing parts.
- This product is intended for use by children from 3 to 8 years of age.
- This unit is designed to be used by up to 5 children, with a maximum weight of 45kg each, simultaneously not to exceed a combined weight of 225kg.
- Do not stand on the swing seats.
- Assembly by adults.
- Adult supervision at all times.
- Only for outdoor and domestic use.
- Before you start assembly please check all parts are included, if any parts are missing or you need advice, please contact Customer Services: by email [warranty@sportspower.biz](mailto:warranty@sportspower.biz), by phone (+44) 0330 0904 420 or visit [www.sportspowerfit4kids.com](http://www.sportspowerfit4kids.com)

# Before you start...

- We suggest you spend some time reading this guide before following the simple step-by-step assembly instructions.
- Do not discard any of the packaging until you have checked that you have all parts and fittings listed. When discarding packaging take care and consideration for others and the environment.
- When assembling this product be aware of the safety of yourself and others.
- Because of the size of this product we suggest that you assemble it in the area intended for use.
- Some of the assembly will be easier with two people. Seek assistance when lifting large or heavy items.
- Assemble this product on a clean, flat and level surface e.g. the cardboard packaging.
- Keep any tools provided or spare fittings for future use. Only use the tools specified.
- Assemble all parts loosely, by hand, before tightening any bolts or fixings.
- Consider the orientation of the product in relation to its exposure to the sun, to avoid hazards, such as dizziness.

**BEFORE STARTING ASSEMBLY PLEASE CHECK ALL PARTS ARE INCLUDED, IF ANY PARTS ARE MISSING, PLEASE CALL (+44) 0330 0904 420. BY EMAIL [warranty@sportspower.biz](mailto:warranty@sportspower.biz), OR VISIT [www.sportspowerfit4kids.com](http://www.sportspowerfit4kids.com)**

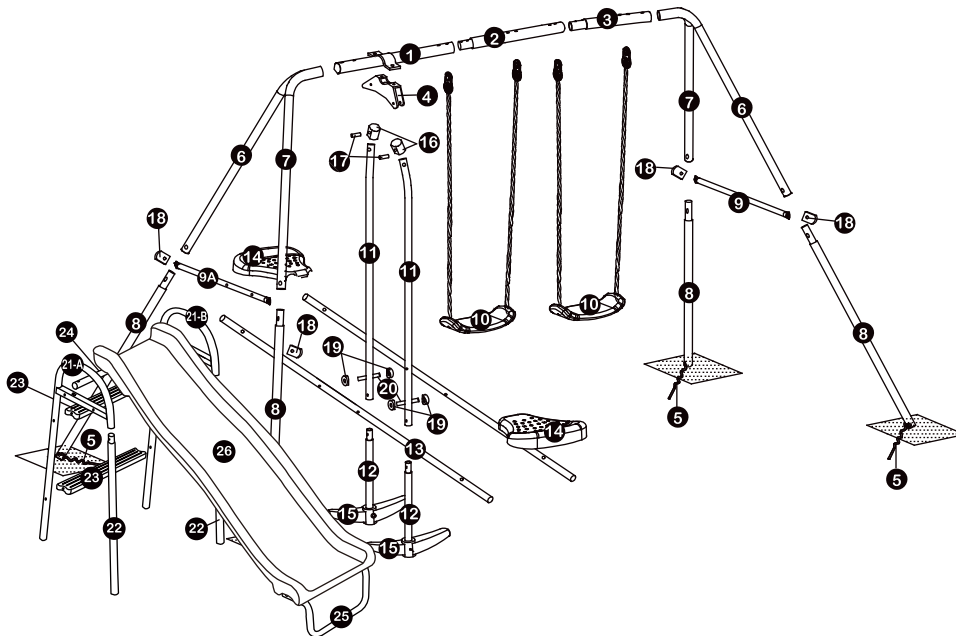

<b>NO.</b>	<b>PART LIST</b>	<b>QTY</b>
1	TOP SUPPORT BAR	1
2	TOP SUPPORT BAR	1
3	TOP SUPPORT BAR	1
4	GLIDER SUPPORT CHANNEL	1
5	ANCHOR	4
6	UPPER LEG	2
7	UPPER LEG	2
8	LOWER LEG	4
9	CROSS BAR	1
9A	CROSS BAR	1
10	SWING SEAT	2
11	GLIDER TOP TUBE	2
12	GLIDER LOWER TUBE	2
13	GLIDER SEAT TUBE	2
14	GLIDER SEAT	2
15	FOOTREST	2
16	PLASTIC CONNECTOR	2
17	PLASTIC TUBE	2
18	PLASTIC CAP	4
19	PLASTIC CONNECTOR	4
20	PLASTIC SLEEVE	2
21A	SLIDE SUPPORT	1
21B	SLIDE SUPPORT (WITH OPENING)	1
22	SLIDE LEG TUBE	2
23	SLIDE LADDER STEPS	2
24	SLIDE TOP SUPPORT BAR	1
25	SLIDE FRONT SUPPORT	1
26	SLIDE	1
27	PLASTIC CONNECTOR	2

For faulty or missing parts please contact customer services: call (+44) 0330 0904 420, Email [warranty@sportspower.biz](mailto:warranty@sportspower.biz) or visit [www.sportspowerfit4kids.com](http://www.sportspowerfit4kids.com)

**contents**

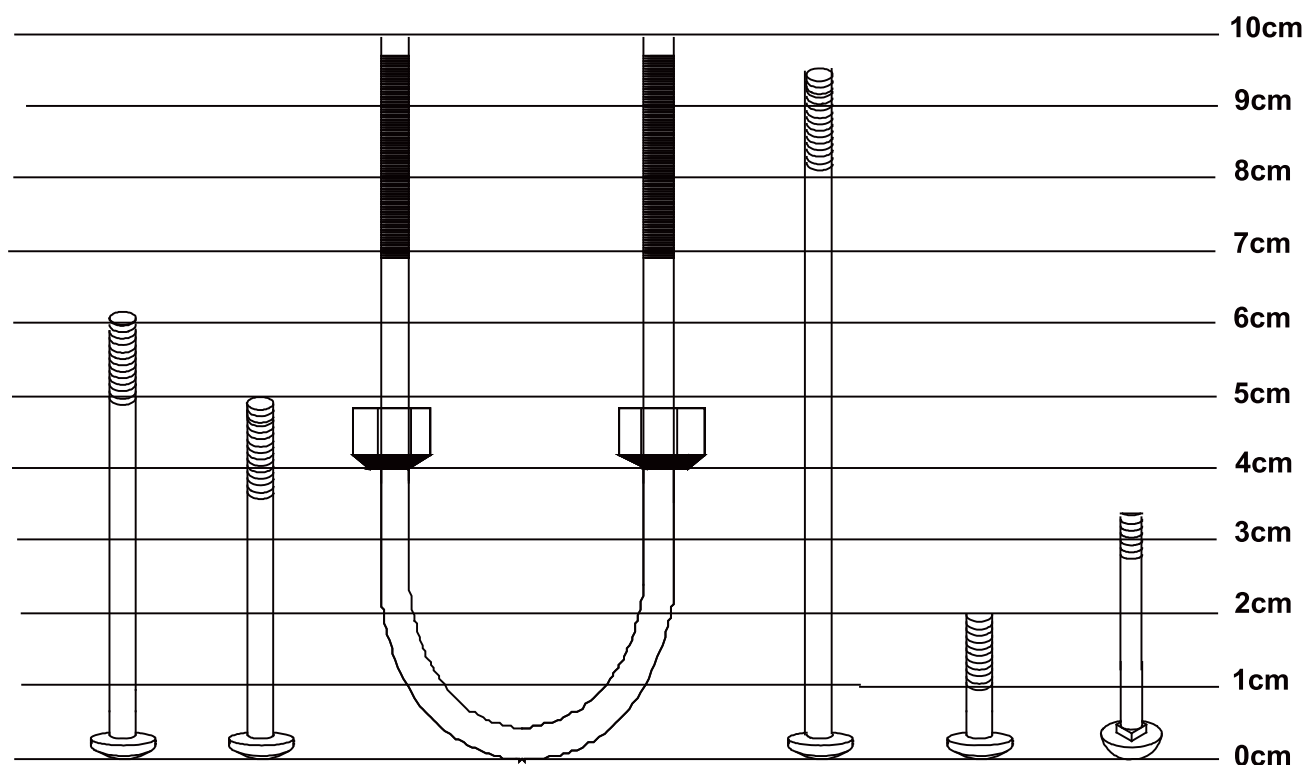

**X3**  
M8×61mm

**X2**  
M8×50mm

**X4**  
M8×114mm

**X2**  
M8×95mm

**X2**  
M8×20mm

**X4**  
M6×36mm

**A**  
BOLT

**B**  
BOLT

**C**  
"U" BOLT

**D**  
BOLT

**E**  
BOLT

**F**  
BOLT

For faulty or missing parts please contact customer services: call (+44) 0330 0904 420,  
Email [warranty@sportspower.biz](mailto:warranty@sportspower.biz) or visit [www.sportspowerfit4kids.com](http://www.sportspowerfit4kids.com)



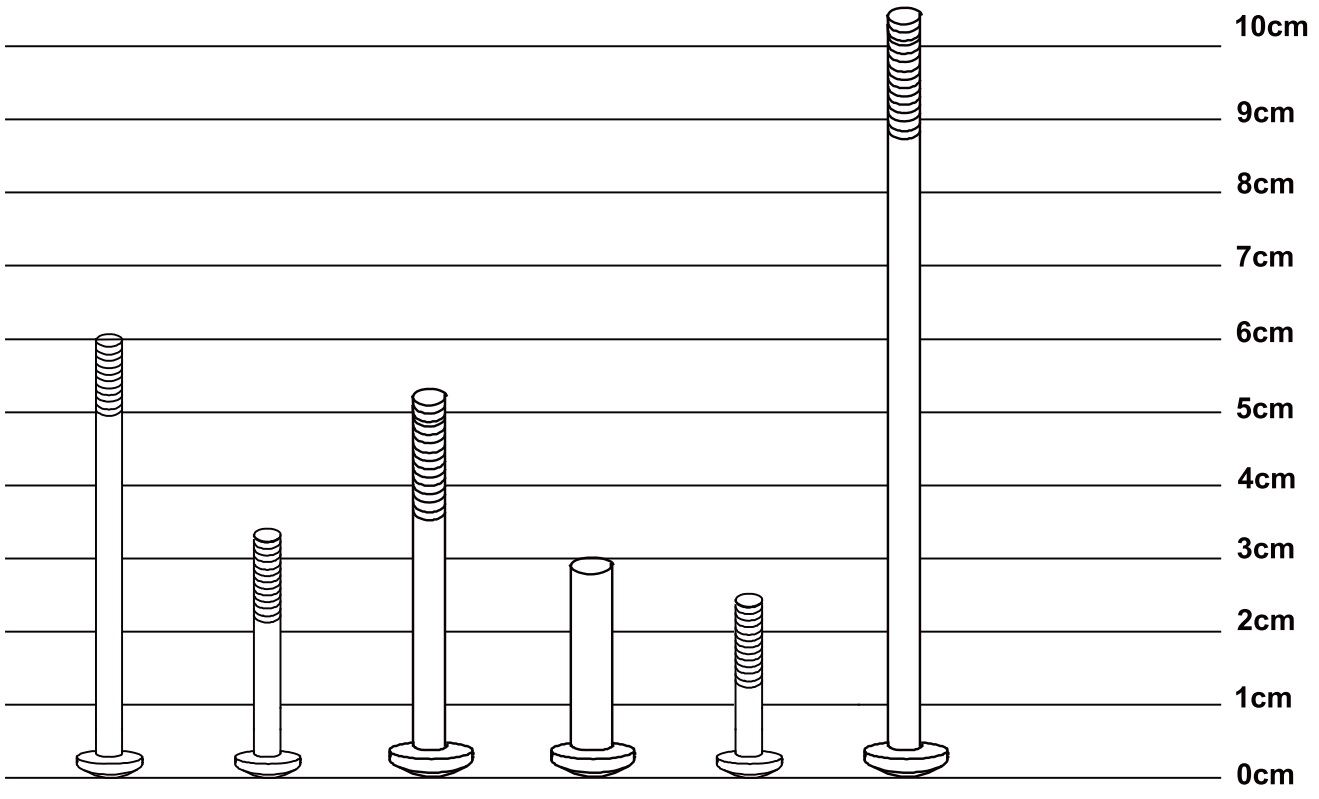



**contents**

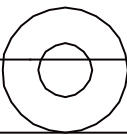

<b>X8</b> M6×60mm	<b>X6</b> M6×34mm	<b>X4</b> M8×53mm	<b>X4</b> M8×30mm	<b>X2</b> M6×25mm	<b>X2</b> M8×115mm
<b>G</b> BOLT	<b>H</b> BOLT	<b>S</b> BOLT	<b>T</b> BOLT	<b>U</b> BOLT	<b>W</b> BOLT

For faulty or missing parts please contact customer services: call (+44) 0330 0904 420,  
 Email [warranty@sportspower.biz](mailto:warranty@sportspower.biz) or visit [www.sportspowerfit4kids.com](http://www.sportspowerfit4kids.com)

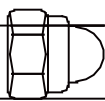
**contents**

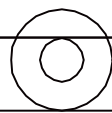
								10cm
								9cm
								8cm
								7cm
								6cm
								5cm
								4cm
								3cm
								2cm
								1cm
								0cm
<b>X30</b>	<b>X12</b>	<b>X12</b>	<b>X25</b>	<b>X22</b>	<b>X21</b>	<b>X18</b>	<b>X18</b>	
Φ8.5xΦ19mm	Φ8.5xΦ19mm	Φ6.5xΦ14mm	Φ8.5xΦ13.5mm	Φ6.5xΦ10mm	M8	M6	Φ6.5xΦ13mm	
<b>I</b>	<b>J</b>	<b>K</b>	<b>L</b>	<b>M</b>	<b>N</b>	<b>O</b>	<b>V</b>	
ARC WASHER	FLAT WASHER	ARC WASHER	SPRING WASHER	SPRING WASHER	NUT	NUT	FLAT WASHER	

For faulty or missing parts please contact customer services: call (+44) 0330 0904 420,  
 Email [warranty@sportspower.biz](mailto:warranty@sportspower.biz) or visit [www.sportspowerfit4kids.com](http://www.sportspowerfit4kids.com)

**contents**

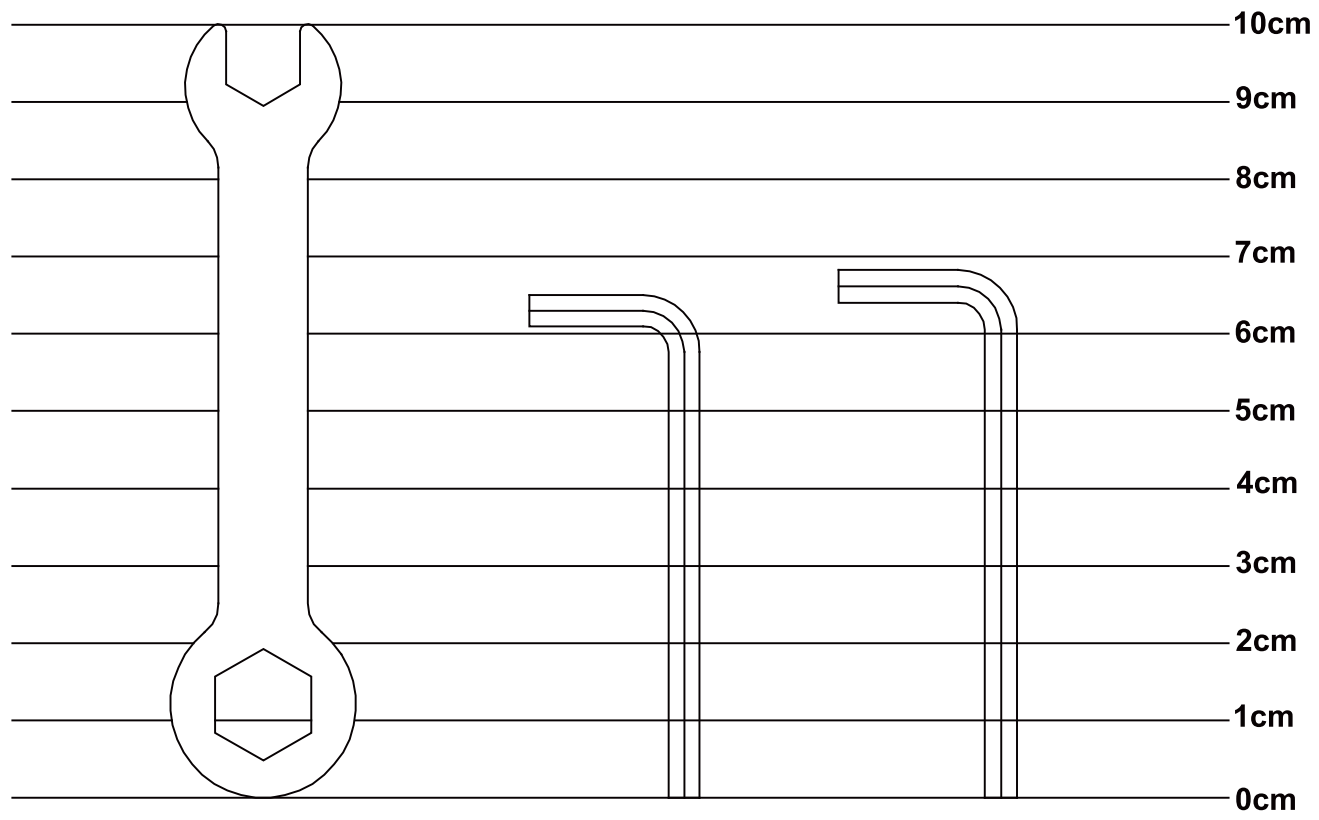

**X1**  
**P**  
SPANNER

**X1**  
**Q**  
ALLEN KEY





**X1**  
**R**  
ALLEN KEY

For faulty or missing parts please contact customer services: call (+44) 0330 0904 420, Email [warranty@sportspower.biz](mailto:warranty@sportspower.biz) or visit [www.sportspowerfit4kids.com](http://www.sportspowerfit4kids.com)

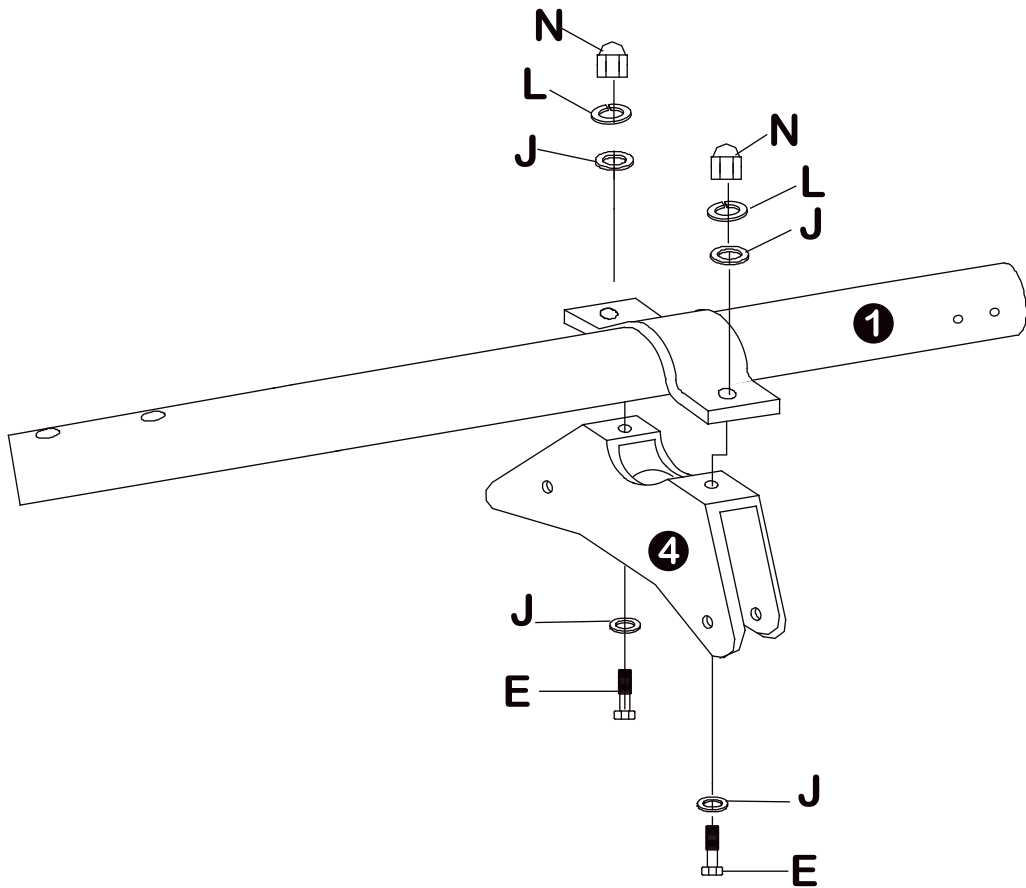
assembly

step 1







			
E	J	L	N
x 2pcs	x 4pcs	x 2pcs	x 2pcs

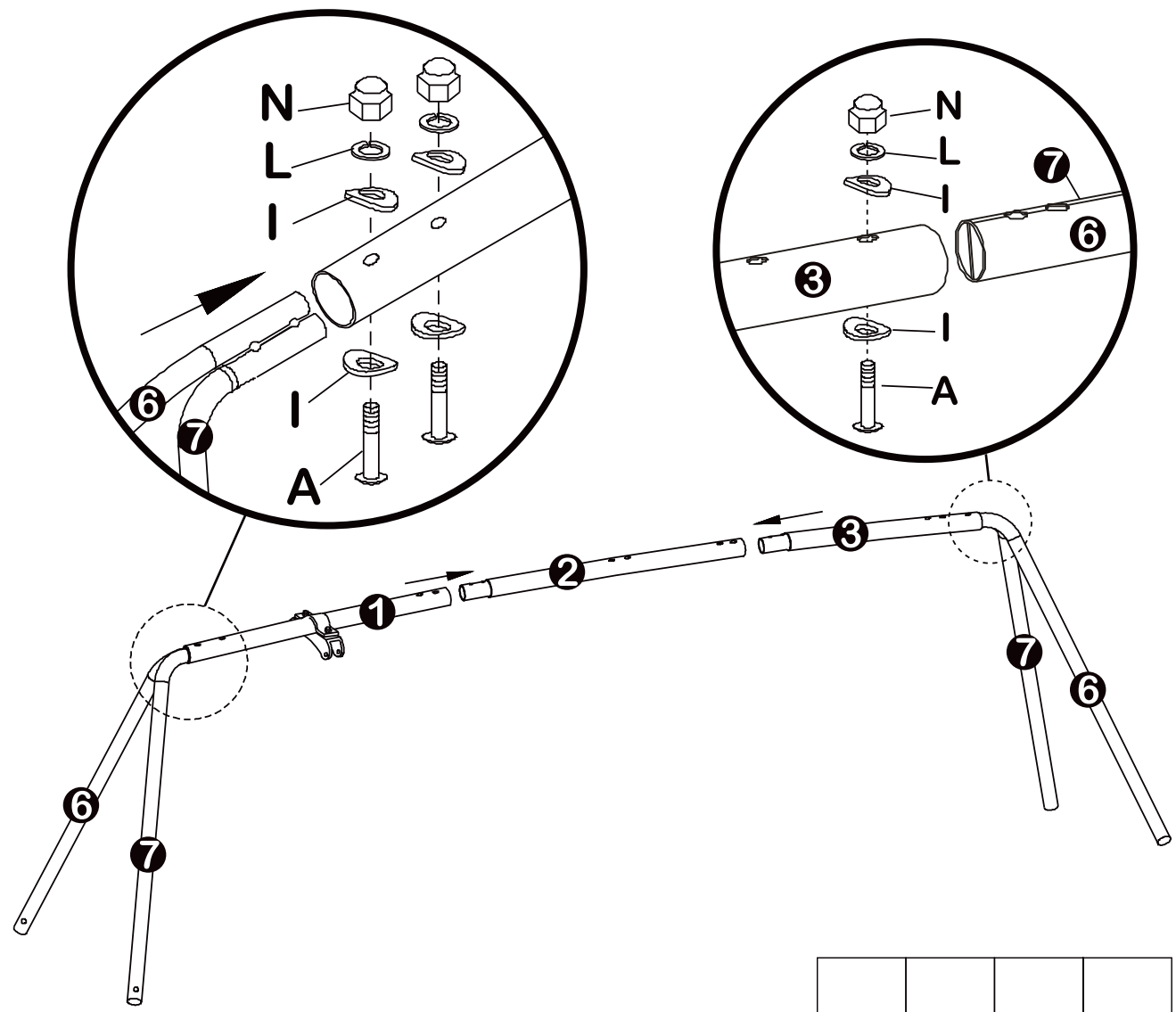

step 2

NOTE: MAKE SURE THE UPPER LEGS 6 AND 7 ARE INVERSED ON THE TWO SIDES.



			
A	I	L	N
x 3pcs	x 6pcs	x 3pcs	x 3pcs

**assembly**

**step 3**

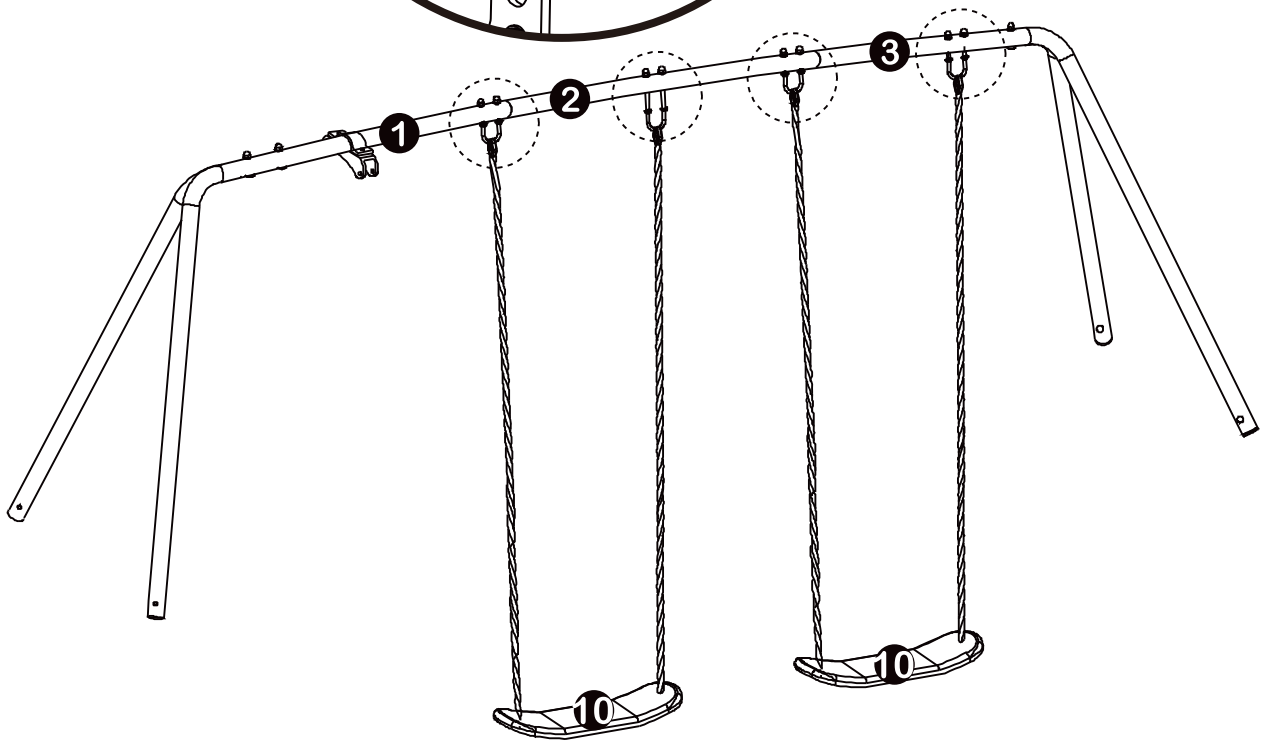
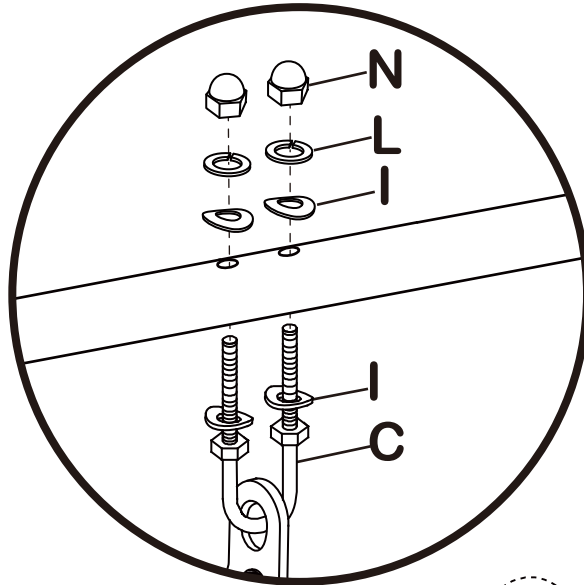



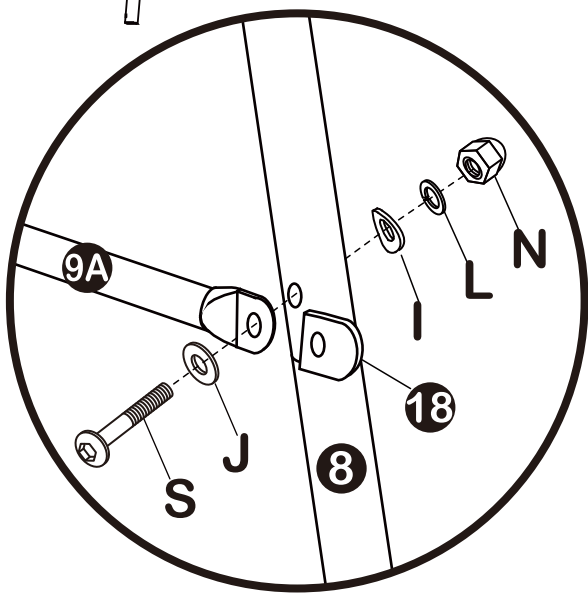
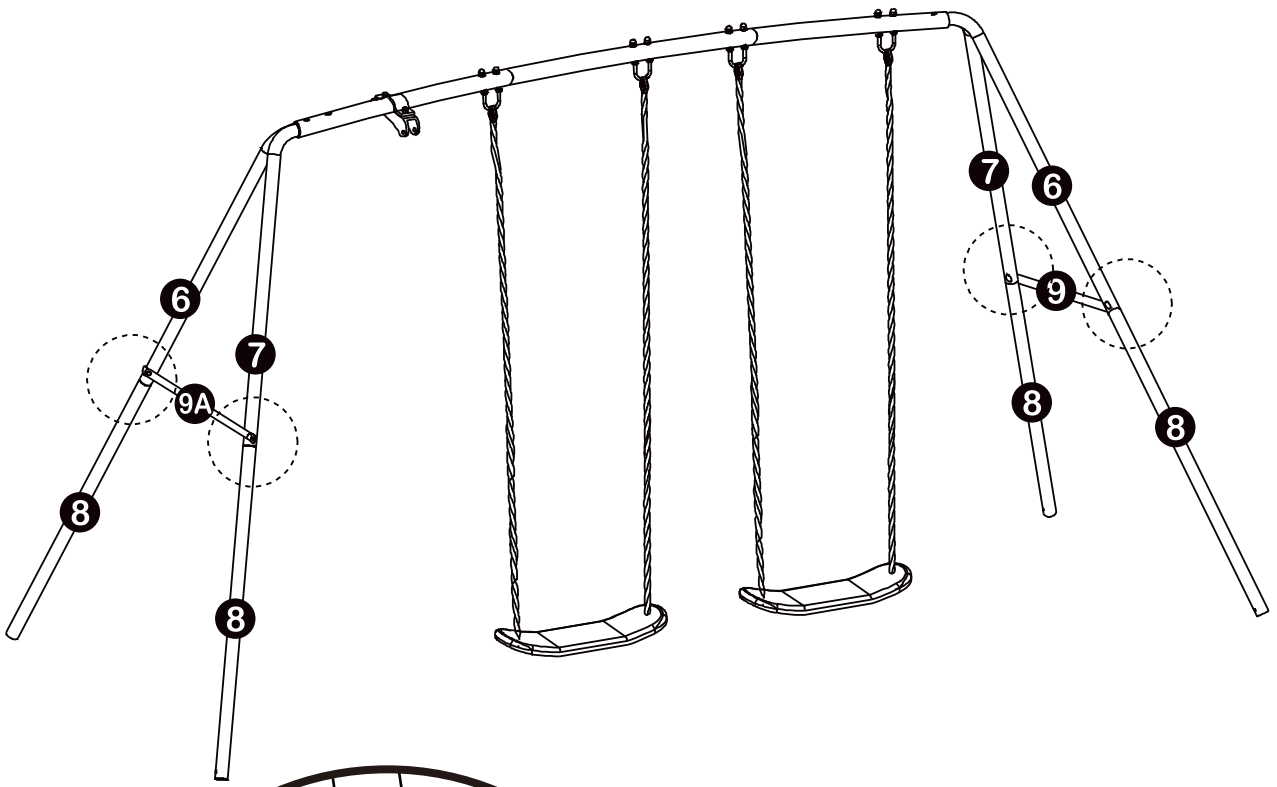

<b>C</b>	<b>I</b>	<b>L</b>	<b>N</b>
x 4pcs	x 16pcs	x 8pcs	x 8pcs

step 4

INSERT LOWER LEG (8) INTO UPPER LEG (6 AND 7) AND CONNECT TOGETHER WITH CROSS BAR (9). MAKE SURE TO ATTACH PLASTIC CAP (18) TO CROSS BAR (8) FIRST.





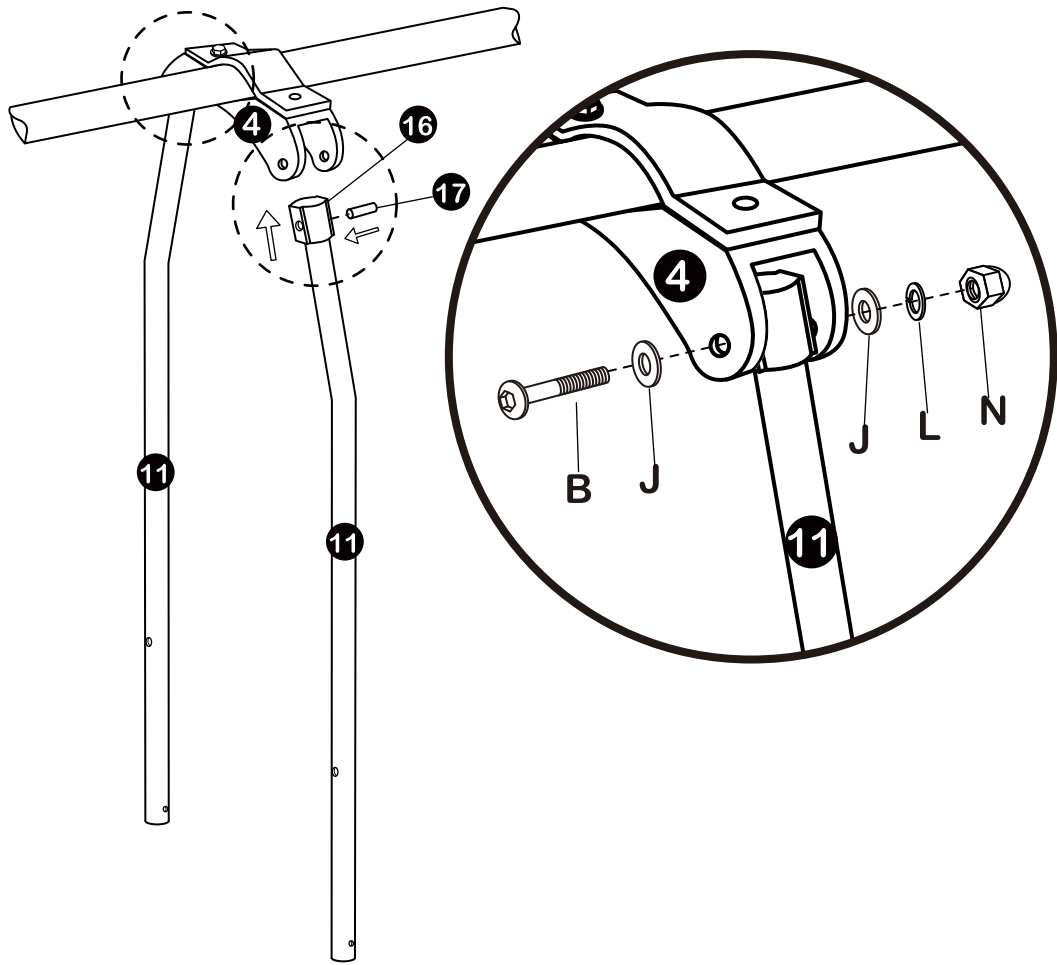

				
S	J	I	L	N
x 4pcs	x 4pcs	x 4pcs	x 4pcs	x 4pcs

step 5

NOTE : ENSURE TO INSERT PLASTIC TUBE(17) FIRST.









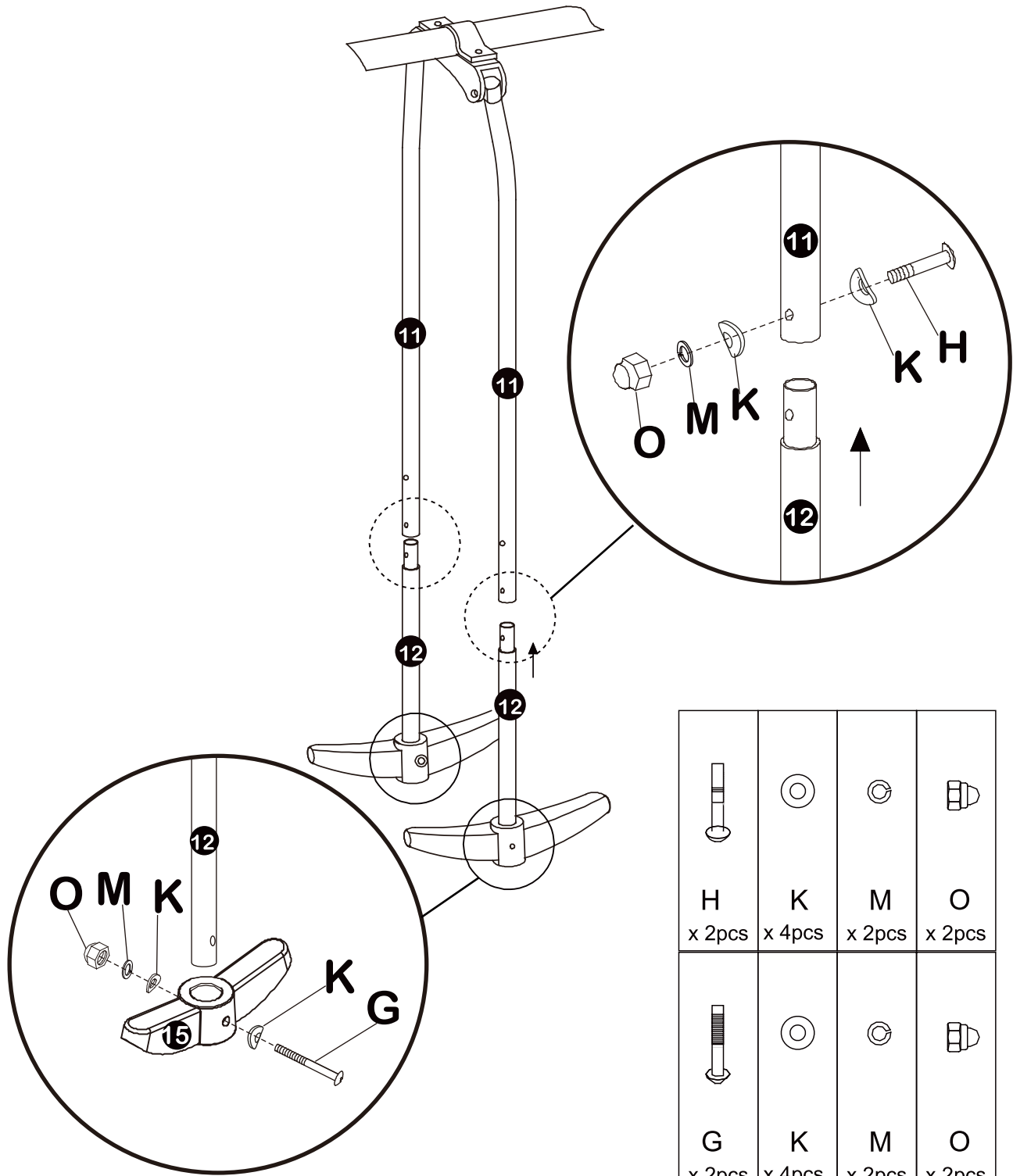

			
<b>B</b>	<b>J</b>	<b>L</b>	<b>N</b>
x 2pcs	x 4pcs	x 2pcs	x 2pcs

**assembly**







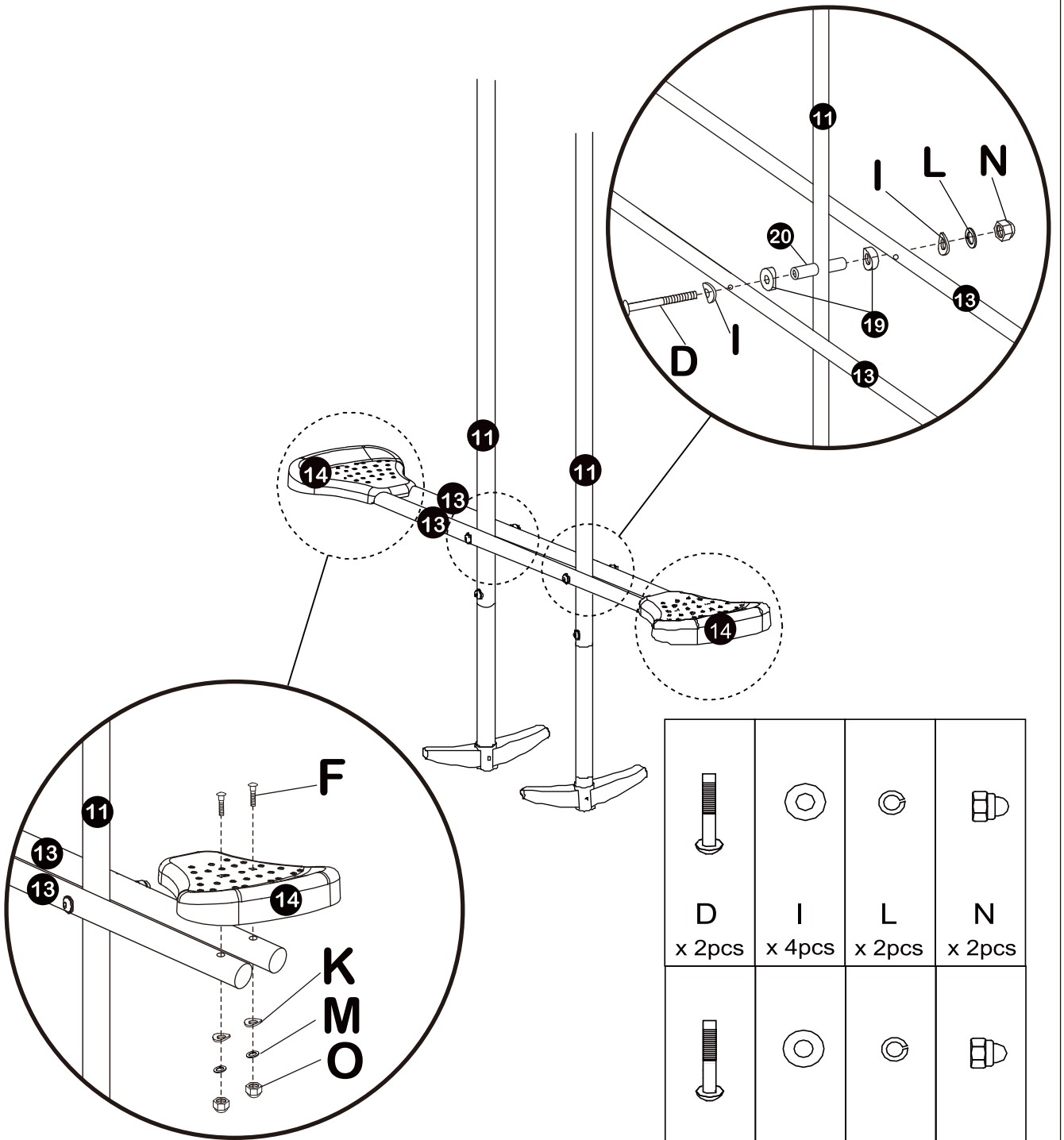

**step 6**



			
H x 2pcs	K x 4pcs	M x 2pcs	O x 2pcs
			
G x 2pcs	K x 4pcs	M x 2pcs	O x 2pcs





step 7

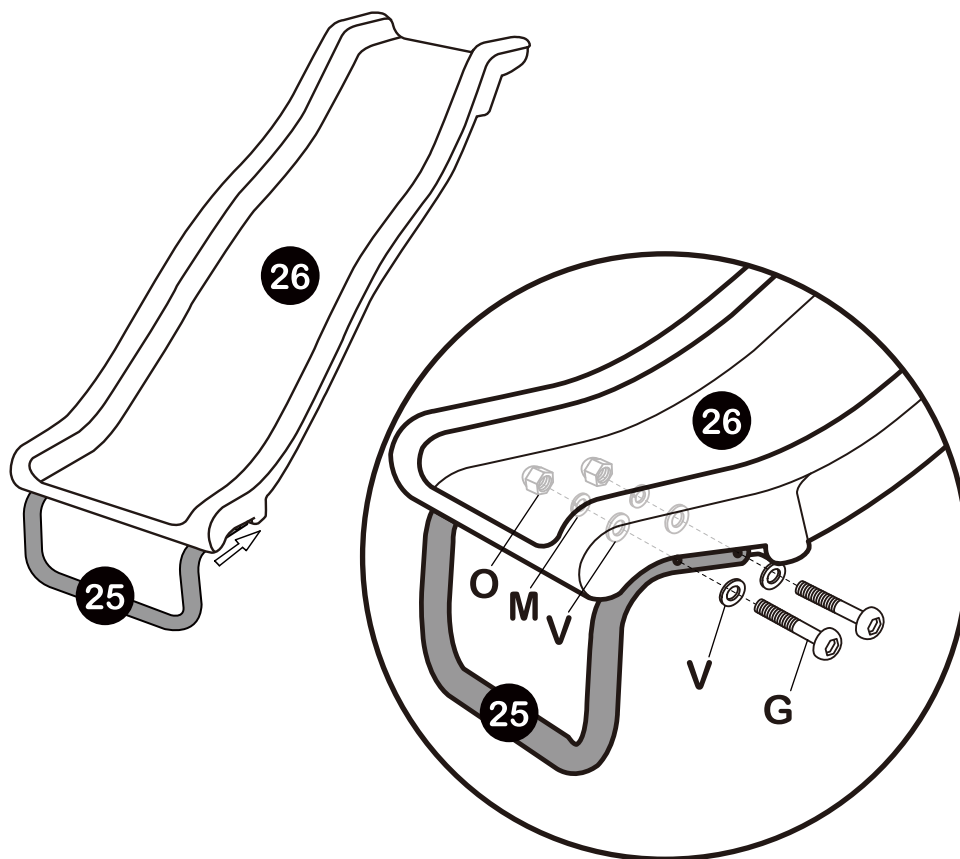

			
D x 2pcs	I x 4pcs	L x 2pcs	N x 2pcs
			
F x 4pcs	K x 4pcs	M x 4pcs	O x 4pcs

step 8





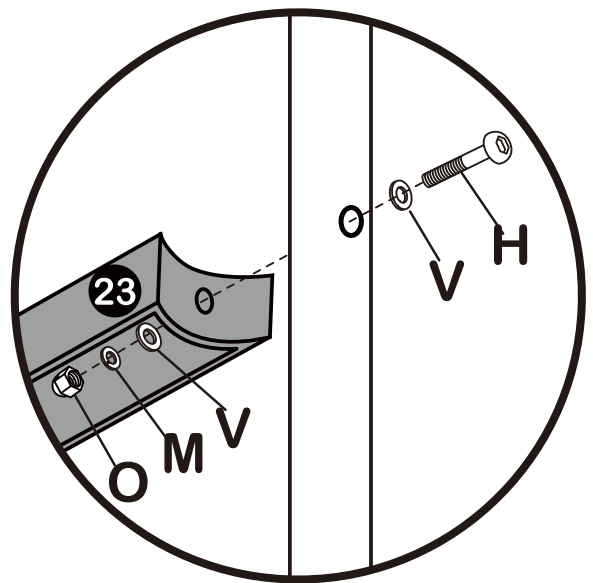
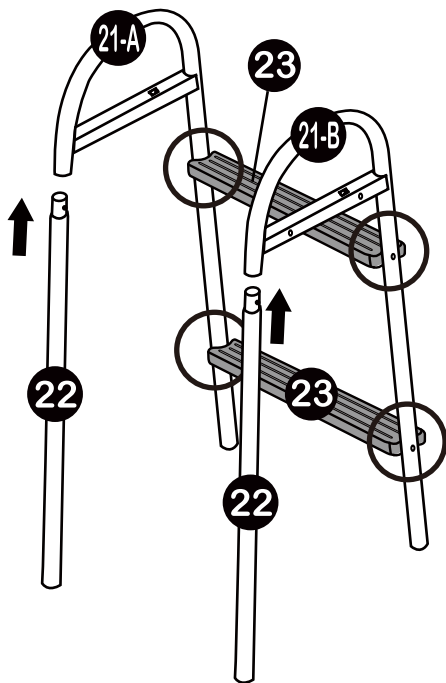

			
<b>G</b>	<b>V</b>	<b>M</b>	<b>O</b>
x 4pcs	x 8pcs	x 4pcs	x 4pcs

**assembly**

**step 9**







			
<b>H</b>	<b>V</b>	<b>M</b>	<b>O</b>
x 4pcs	x 8pcs	x 4pcs	x 4pcs

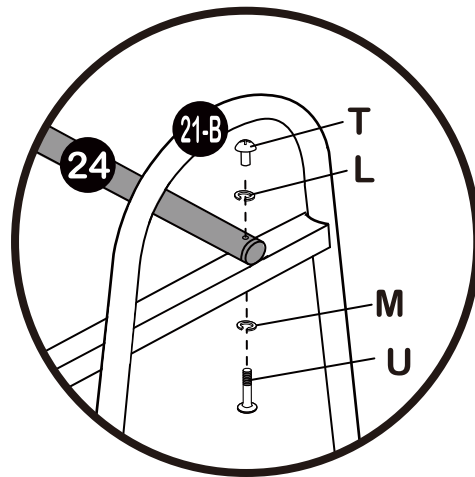
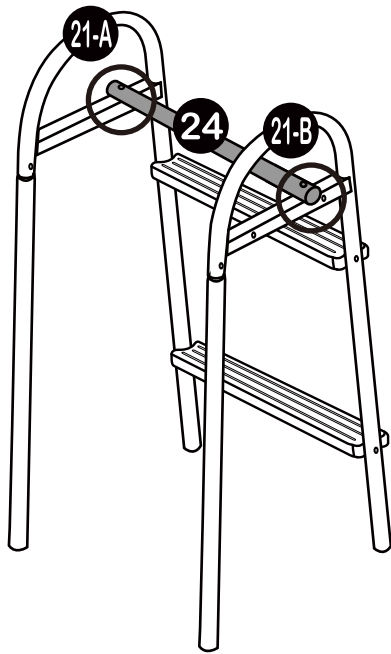

step 10





			
U	L	M	T
x 2pcs	x 2pcs	x 2pcs	x 2pcs

assembly

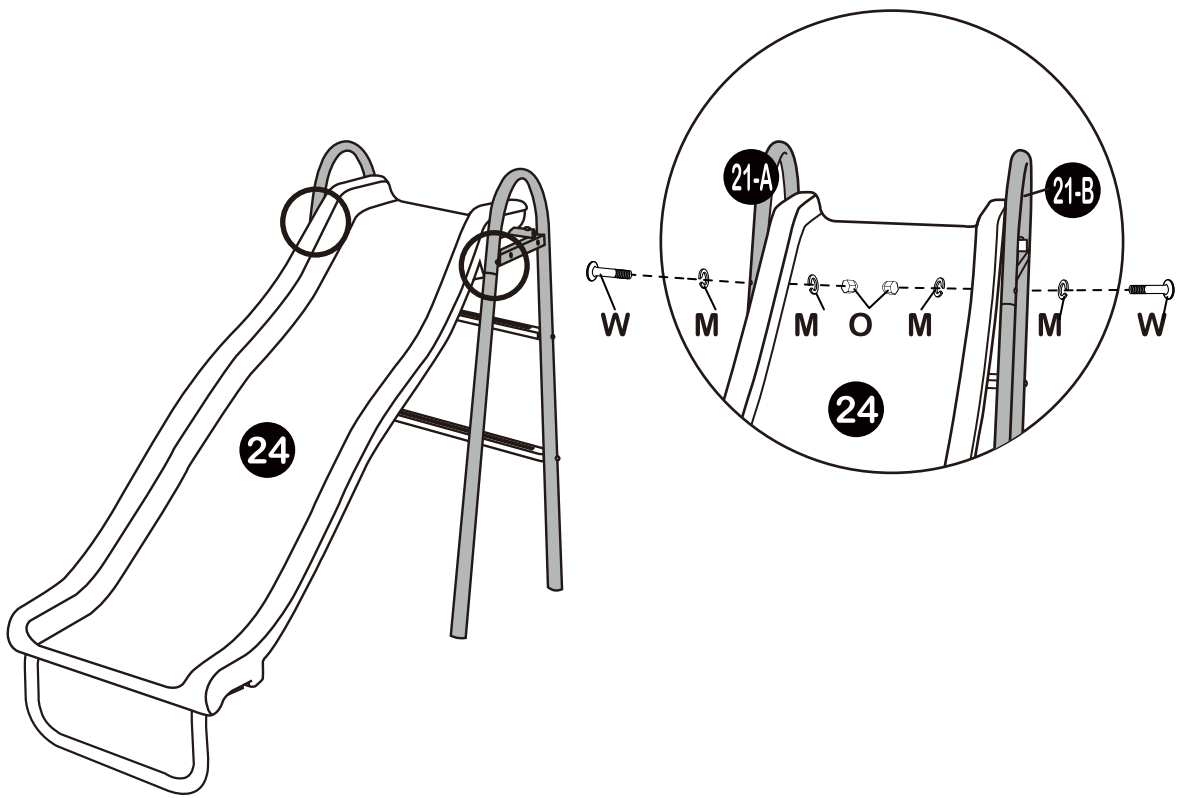



step 11

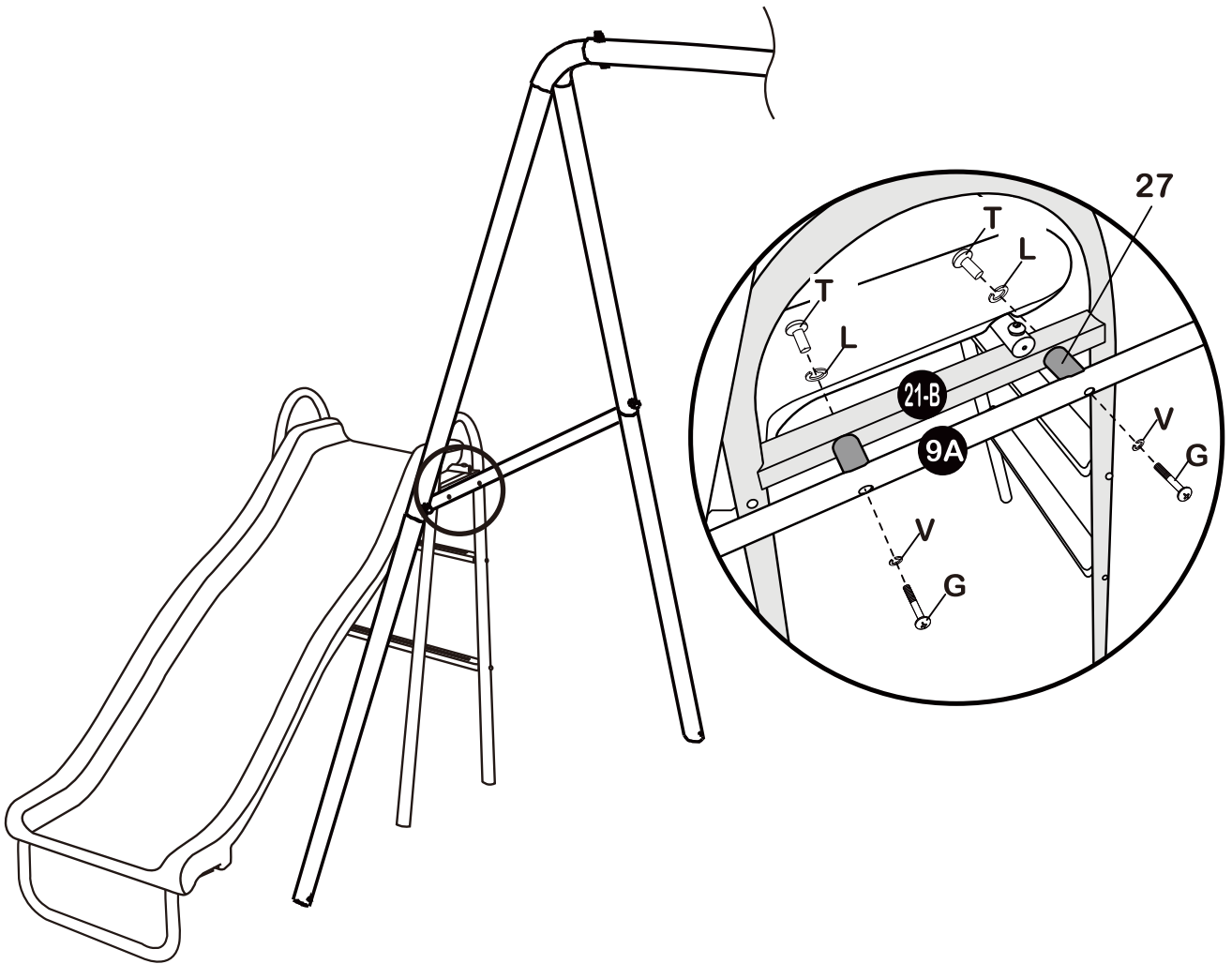

		
W	M	O
x 2pcs	x 4pcs	x 2pcs

step 12



			
<b>G</b>	<b>V</b>	<b>L</b>	<b>T</b>
x 2pcs	x 2pcs	x 2pcs	x 2pcs

step 13

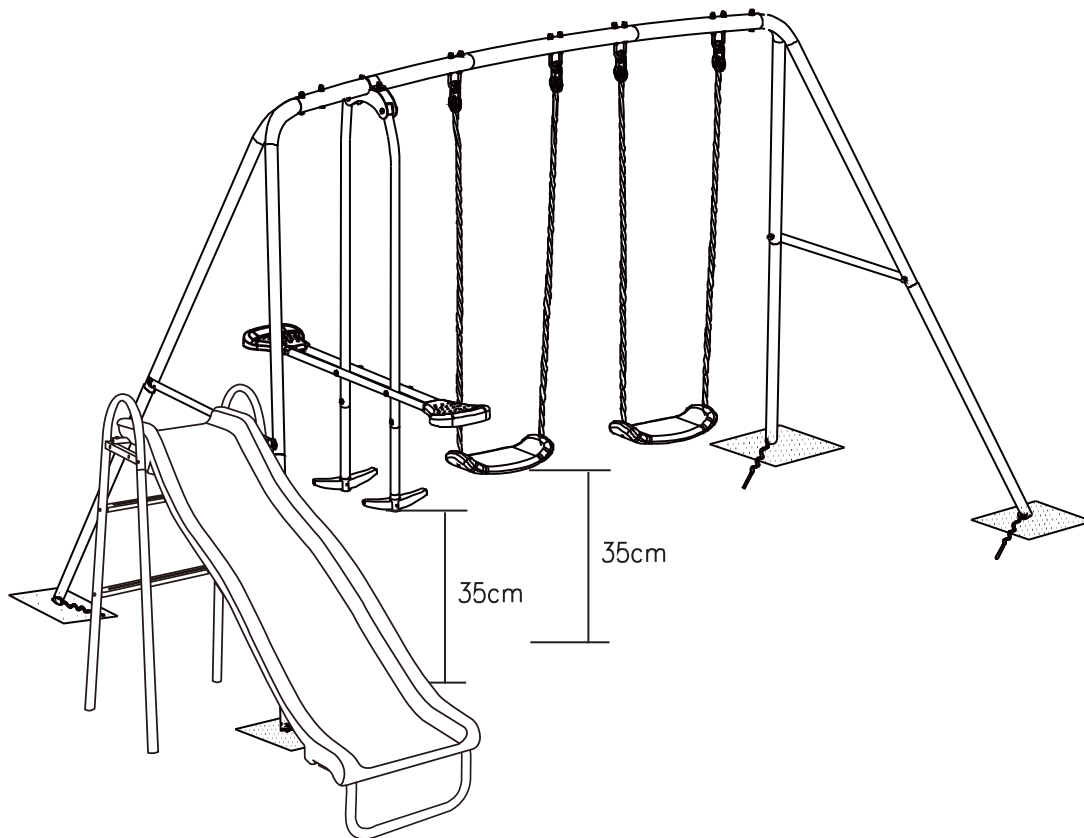

**IMPORTANT:** The product must be anchored into the ground. For optimum safety and performance, we recommend concreting in the corners as shown in the diagram.

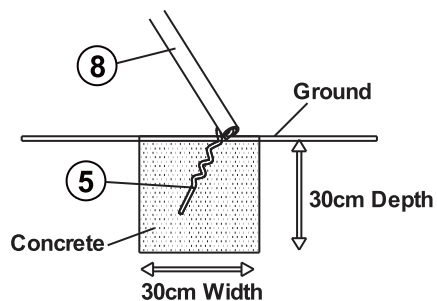
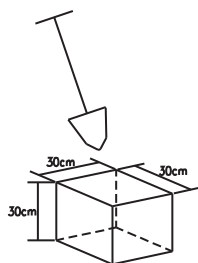

### SEAT ADJUSTABLE GUIDE

THE LENGTH OF THE ROPE IS ADJUSTABLE FOR THE HEIGHT OF THE CHILD THROUGH THE SEAT CONNECTOR.

TO ADJUST, LOOSEN THE KNOT ON THE SEAT CONNECTOR, PULL ROPE THROUGH THE HOLES AND TIGHTEN AGAIN.

MAKE SURE THAT THE KNOTS ARE TIGHT AND THAT BOTH ROPES ARE ADJUSTED SO THAT THE SEAT IS HORIZONTAL.

**IMPORTANT: MINIMUM CLEARANCE BETWEEN THE FOOTREST/SEAT AND THE GROUND SHOULD BE 35 CM.**

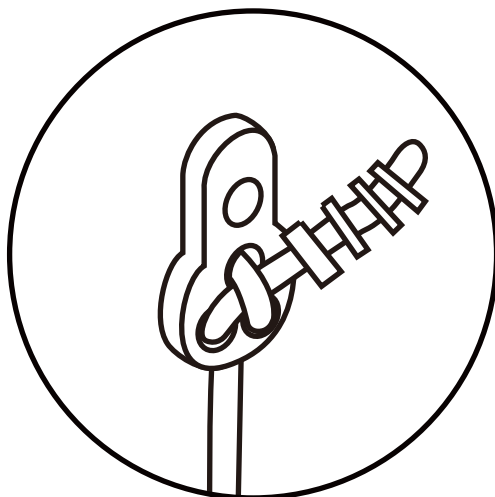

SEAT CONNECTOR

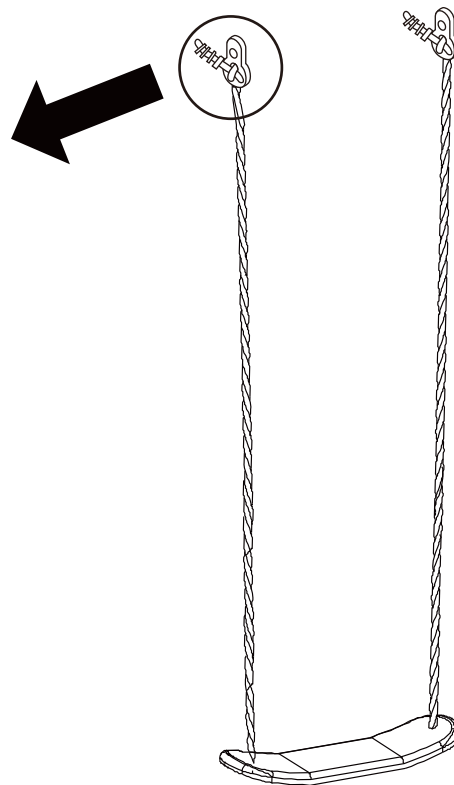



## Warning

- NOT suitable for children under 36 months. Small parts and long cord-choking hazard.
  - Avoid children facing the sun whilst using the equipment to avoid hazards, such as dizziness.
  - Adult supervision is required at all times. Never leave children unattended.
  - Product MUST be assembled and checked by an adult.
  - This product is only intended for outdoor domestic use.
  - Only one child per swing seat at any one time.
  - Age recommendation for this product is 3-8 years.
  - Max. user weight for each swing seat is 45kg.
  - The Minimum distance from bottom of the swing seat to the ground must be 35 cm ( 14 inches).
  - DO NOT stand on swing seat. DO NOT stand on glide ride seat.
  - Product must be assembled and used on a flat and level surface at least 2 metres ( 7.5 feet ) from any structures or obstructions such as fences, walls, garden borders, washing lines, electrical cables.
  - The product must be secured using the anchors provided. The anchors must be placed level with, or under, the ground in order to reduce tripping hazards.
  - Ensure the product is installed over a soft surface, such as grass or sand, or wood bark which should have a depth of minimum 15 cm ( 6 inches). Installation area should be regularly checked and any shock absorbing materials replenished to maintain a correct depth regarded suitable for the product otherwise injuries may occur from a fall.
  - DO NOT install the unit over concrete, asphalt, gravel or any hard surface which may cause injury should a fall occur.
  - DO NOT allow children to use the product until it has been properly assembled, anchored and checked by an adult.
  - Ensure children wear suitable clothing whilst using the product. Do not allow loose clothing, clothing with draw - strings, jewellery or any article of clothing that might be potentially hazardous whilst using the product.
  - DO NOT let children use this equipment in any manner other than the correct intended use.
  - DO NOT allow children to dis-mount any ride or swing whilst still moving.
  - DO NOT allow children to wander into the play area when the product is in use.
  - DO NOT allow children to climb or play on the product whilst the product is wet as slips or falls may occur.
- DO NOT allow children to swing empty rides as they may strike and injure other children.
- DO NOT allow children to twist or ropes loop them over the support bar as this will cause damage and may result in injury.
  - DO NOT allow children to swing play equipment more than 60 degrees.
  - DO NOT attach items to the product that are not specifically designed for use with the product; such as, but not limited to, cables, skipping ropes, nursery swing seats as they may cause injury.
  - Remove and dispose of all packaging materials before the product is used.
  - Once assembly is complete carefully check the equipment before use to ensure all parts are correctly assembled. Check all nuts and bolts are tightened. If you find any problems do not allow children to use the product until it is fit for use

- Check all parts of the product at regular intervals, especially the top beam, frame legs, ropes and ride supports. If you find any problems do not allow children to use the product until it is fit for use. If these checks are not carried out the product could over-turn or otherwise become a hazard
- Check metal sections and components for signs of corrosion.
- Discontinue use if any weakening or breakage is found.
- The product has maintenance instructions highlighting the need to carry out checks and maintenance of the main parts at regular intervals. Whenever practical, the maintenance instructions shall also be affixed to the toy.
- Please retain these instructions for future reference.
- Teach children to use the product correctly and sit in the centre of ride seats whilst in use

## TIGHTENING NUTS & BOLTS

- At the start of assembling DO NOT FULLY tighten bolts / nuts all the way so as to allow some possible adjustment for ease of assembly.
- DO NOT use pliers to tighten up screws as they can cause damage to paintwork and nuts and bolts.
- After all major components are assembled go back over all bolts and nuts and properly tighten all before using the product.



## Maintenance

- Check swing and ride seats for any evidence of deterioration, cracks or exposed edges which could cause injury. If there are any such problems contact the HELP LINE: (+44) 0330 0904 420 by email support@sportspowerfit4kids.com, or visit www.sportspowerfit4kids.com for replacement parts.
- Carry out checks and maintenance of the main frame parts- cross beam, legs, ropes, anchors, nuts, bolts and rides before each play session and at least every two weeks.
- Check all nuts, bolts and fittings for tightness and tighten if required.
- Check unit for sharp edges which may have occurred during shipping, assembly, abuse or everyday usage. Replace if required.
- Check to ensure all rides are correctly fixed to the top beam according to the instructions.
- Oil all metallic moving parts monthly during the main usage period.
- To help maintain the products appearance, occasionally clean the seats and metal framework with a damp cloth lightly – but do not use abrasive chemical cleaners.
- When you wish to disassemble or dispose of the product please completely disassemble the unit and discard of it in a safe place and manner so as not to present any hazard to any individual.

## PRODUCT WARRANTY

All warranty coverage extends only to the original purchaser of the product and is not assignable or transferable. The original store or online purchase receipt must be kept as proof of purchase in order for the warranty to be valid. These documents must be presented in the event of making a claim under warranty.

During the warranty period, Sportspower will provide repair or replacement of defective equipment or parts thereof covered by the warranty. Any handling, transportation, delivery and other incidental charges in respect of the servicing of the equipment shall be borne by the Purchaser. If the product includes a number of accessories, only the defective part or accessory will be replaced.

The warranty will become void if any defects or damages are associated with the use of unauthorized replacement parts. All replacement parts must be obtained from Sportspower authorized agents.

All decisions made by Sportspower in respect of the servicing of the equipment (including repairs, replacements or issues relating to defects of workmanship or materials) shall be conclusive and the Purchaser agrees to be bound by such decisions. Any defective equipment or part thereof replaced shall become the property of Sportspower.

In the event of a product or accessory being replaced during the guarantee, the guarantee on the replacement will expire at the original date, 6 months from the original purchase date.

This warranty excludes defects caused by the product not being used in accordance with instructions, accidental damage, misuse or being tampered with by unauthorized persons.

The Sportspower Limited Warranty does not cover:

(a) Products used for commercial or rental purposes.

(b) Loss or damage to product due to: (i) abuse, repairs and/or tampering by any person other than the authorized personnel of Sportspower; (ii) negligence and/or misuse (including foreign object, accident, improper storage, exposure to sun/moisture, excessive temperature, sand, dust, dirt, other pollution or other environmental conditions and failure to follow precautions or proper operating instructions stated in the User's Manual such as improper installations); (iii) fire, flood, lightning strike, wind storm or other acts of God; (iv) freight or improper transport damages, and (v) improper usage (including use by under-age, over-weight or excessive number of users permitted as stated in the User's Manual).

(c) Defects, damages or accidents due to the malfunction, connection to or use of non-Sportspower or unauthorized parts. In such event, Sportspower reserves the right to cancel the Limited Warranty coverage immediately.

To the extent allowed by the applicable local law, the remedies in the Limited Warranty are the Purchaser's sole and exclusive remedies.

SPORTSPOWER IS NOT RESPONSIBLE OR LIABLE FOR INDIRECT, SPECIAL OR CONSEQUENTIAL DAMAGES ARISING OUT OF OR IN CONNECTION WITH THE USE OR PERFORMANCE OF THE PRODUCT OR OTHER DAMAGES WITH RESPECT TO ANY ECONOMIC LOSS, LOSS OF PROPERTY, LOSS OF REVENUE OR PROFITS, LOSS OF ENJOYMENT OR USE, COST OF REMOVAL, INSTALLATION OR OTHER CONSEQUENTIAL DAMAGES. SOME STATES DO NOT ALLOW THE EXCLUSION OR LIMITATION OF INCIDENTAL OR CONSEQUENTIAL DAMAGES. ACCORDINGLY, THE ABOVE LIMITATION MAY NOT APPLY TO YOU.

**CUSTOMER SERVICE/ SPARE PARTS -(+44 ) 0330 0904 420**  
**by email [warranty@sportspower.biz](mailto:warranty@sportspower.biz),**  
**or visit [www.sportspowerfit4kids.com](http://www.sportspowerfit4kids.com)**

**Geemac Sales & Marketing Ltd.**  
**20 Queensbridge Bedford Road Northampton,**  
**United Kingdom, NN4 7BF**

Sportspower Ltd.  
20/F, Parkview Centre, 7 Lau Li Street, Causeway Bay, Hong Kong  
[www.sportspowerltd.net](http://www.sportspowerltd.net)