

# 6FT BOUNCY CASTLE

Assembly & User Instructions - Please keep for future reference

367/8604

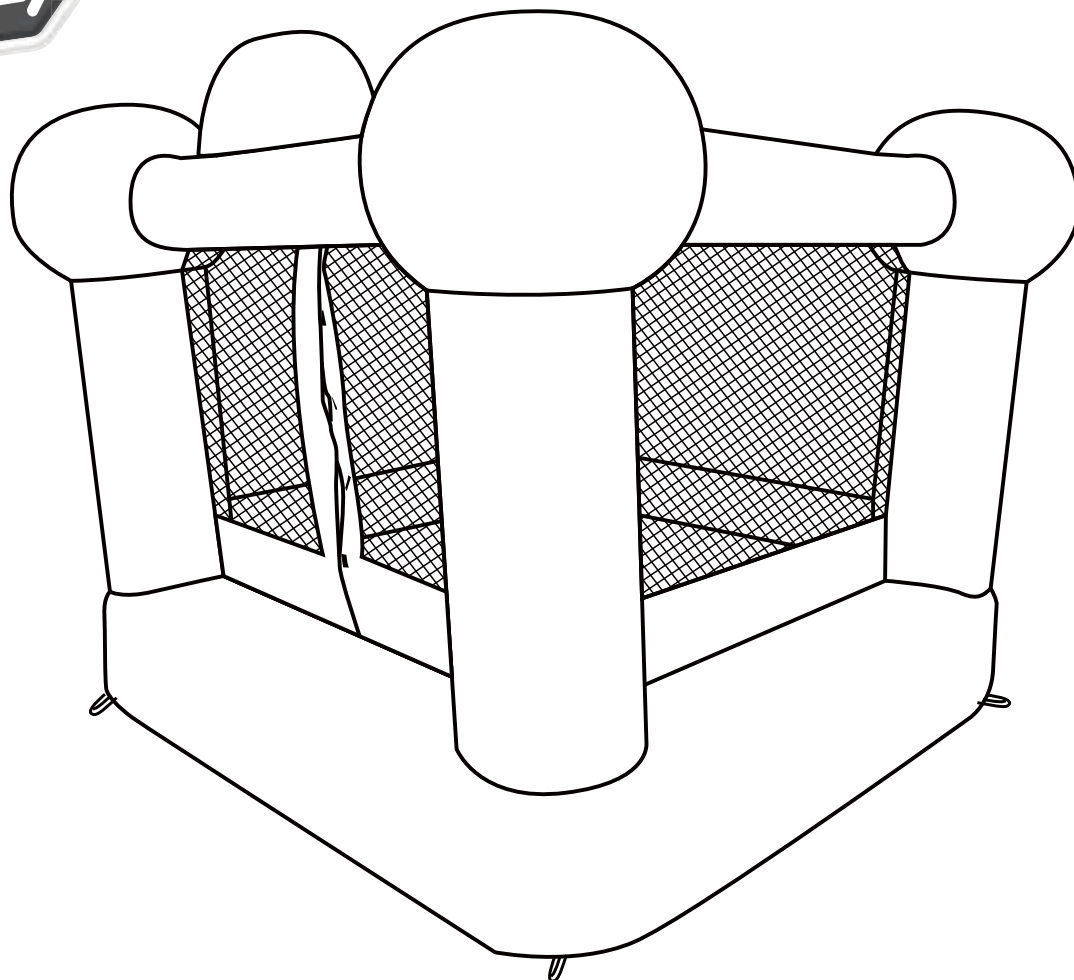

## Important

Age: 3 - 8 years  
Maximum individual user weight: 30kg  
No more than 2 children

Tips: It will take around 2  
minutes to set up.  
1 adult required

**Important** - Please read these instructions fully before assembly or use.

These instructions contain important information which will help you get the best from your product and ensure safe and correct assembly, use and maintenance.

If you need help or have damaged or missing parts, call the **Customer Helpline: (+44) 0330 0904 420**

# Contents

**Important** –Please read these instructions fully before assembly or use.

Blower Safety Information	2
Bouncer Safety Information	3-4
Parts	5
Inflation & Anchoring	6-8
Deflation & Storage	9-10
Repair Instruction	11
Care and Maintenance	12
Warranty Information	13

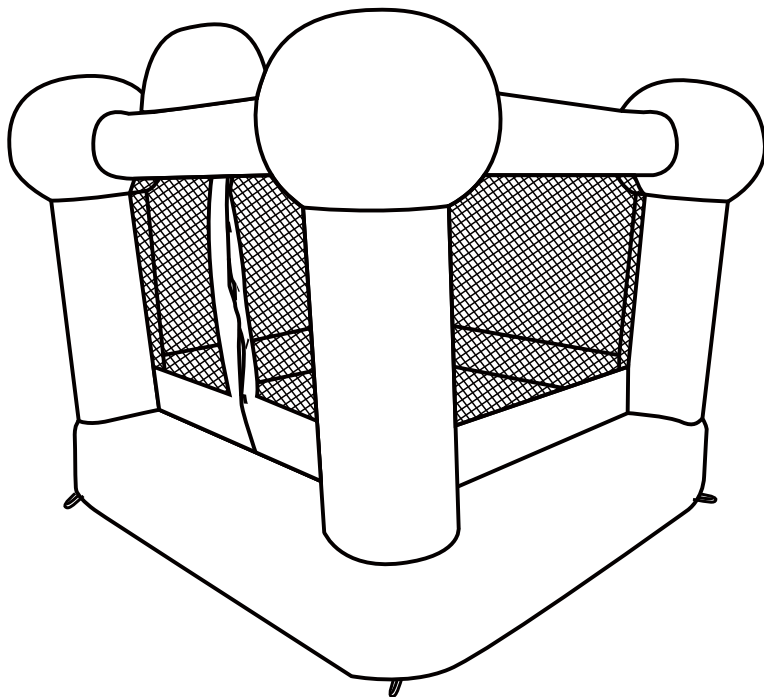



# Blower Safety Information

**Important** –Please read these instructions fully before assembly or use.

## **WARNING**

- Please read before using the air pump and save these instruction for future use.
- This product should only be used for inflating the bouncy castle supplied.
- Do not use air pump if any part is damaged or missing.
- Do not operate the appliance with a damaged cord or plug, or if the appliance malfunctions, or has been damaged in any manner.
- To reduce the risk of electric shock, connect only to a main electric supply outlet provided with a residual current device(RCD).
- Do not use an extension cord with this air fan.
- The appliance must be positioned so that the plug is accessible.
- The fan should never be left unattended when in use. The appliance is not to be used by children.
- Objects should not be allowed to be sucked into the pump.
- To avoid danger of electrical shock, do not use the fan in wet conditions.
- To reduce the risk of fire or electrical shock, do not expose to water or rain.
- If the power supply cord is damaged, it must be replaced by a qualified electrician.
- Under no circumstances should a finger or any sharp object be inserted into the air intake.
- Unplug from outlet when not in use and before cleaning or servicing.
- The air blower should be used outdoor.
- The appliance is not to be used by persons (including children) with reduced physical, sensory or mental capabilities, or lack of experience and knowledge, unless they have been given supervision or instruction .
- Children must be supervised not to play with the appliance.

## **Installation**

- The air blower is first to be placed on the ground and then attached in place with plastic anchors through the fixing holes.
- The air blower should be installed in a well-ventilated location and on a level surface.

## **Using**

- Connect plug to AC 220-240V/50Hz socket.
- Turn on by pushing “I” firmly. Turn off by pushing “o”.

## **Maintenance and storage**

- Always unplug and disconnect the fan from the power supply before servicing or cleaning.
- To keep the fan clean, you can use a dry cloth to wipe the surface of the fan.
- You should not clean the fan with a chemical solution as this may damage the coating and plastic parts.
- Never clean the fan in water.
- The fan should be stored indoors.
- This fan should not be opened or dismantled, as there are no serviceable parts.

**If you need help or have damaged or missing parts, call the Customer Helpline:**

**(+44) 0330 0904 420**

**Produced for Chad Valley Toys, Argos Ltd.**

**Address: 489-499 Avebury Boulevard, Central Millen Keynes, MK9 2NW. [www.argos.co.uk/chadvalley](http://www.argos.co.uk/chadvalley).**



# Bouncer Safety Information

**Important** –Please read these instructions fully before assembly or use.

## **WARNING**

- Carefully read and understand all of the instructions and safety warnings in this manual before assembling and using this product. It is the responsibility of the owner of this product to ensure that all users of this product are fully informed on the proper safe use and the inherent risks of playing on this product. Failure to do so can result in serious injury or death.
- Always use the product in a well-lit area. Do not use without lighting during dawn, dusk or in complete darkness!
- The product must be placed on a surface that is **COMPLETELY FLAT AND LEVEL**. If the ground is uneven, this could cause movement in the product that could cause product damage and/or serious injury.
- **DO NOT** position this product on a hard surface such as concrete, tarmac or paving. Suitable surfaces are grass, sand or a play area covered with an appropriate depth of play bark material.
- Maintain clear space on all sides of the product.
- Areas immediately adjacent to all areas of access/egress of the inflatable device shall have use zones, which are free of obstacles and covered with impact attenuating surfacing for a minimum distance of at least 1.8 m (6ft).
- Make sure that there are no hazardous objects above, below or near the product. Such objects include walls, fences, tree limbs/trunks, electrical power wiring, rocks, sprinkler heads or other recreational objects (i.e. swing sets, swimming pools). Children can be seriously injured by colliding with such obstacles.
- Adequate overhead clearance is essential. A minimum of 24 ft from ground level is recommended. Provide clearance for wires, tree limbs, and other possible hazards. The product must be stored away or disassembled completely during severe windy conditions.
- The product must be used with the anchors provided and installed properly.
- Make sure anchors are completely inserted into the ground to reduce tipping hazards.
- Do not use the product while holding or wearing any type of sharp or pointed objects such as jewelry, watches, rings, eyewear and necklaces.
- Do not wear loose fitting clothing that may catch or snag during play.
- No shoes or glasses are to be worn on the inflatable device.
- Always tie back long hair so that it does not block user's vision or get caught in the safety netting.
- Restrict away consumption of food, drink and gum.
- Do not attach items to the inflatable device that are not specifically designed for use with the inflatable device, such as, but not limited to, jump ropes, clothesline, pet leashes, cables and chain as they have the potential to cause a strangulation hazard.
- Do not allow pets in or around the product.
- Do not jump on the product with any play objects, including but not limited to, skateboard, roller blades or any other equipment. **DO NOT** hold any foreign objects not authorized by the manufacturer in your hand and **DO NOT** place any objects on the product while anyone is jumping on it. Please be aware of your surroundings to ensure there are no objects that could cause harm.
- Always keep hands and feet inside product during use.
- Children **MUST NEVER** be left unattended inside the enclosure at any time.
- The enclosure netting is **ONLY** intended to be used to reduce the risk of injury from falling off the product. Do not intentionally kick, bounce against, climb on, hang from or jump over the netting.
- Enter and exit the enclosure only through the enclosure door opening. Do not attempt to climb over the product.



# Bouncer Safety Information

**Important**—Please read these instructions fully before assembly or use.

## **DANGER**

- Adult supervision is required at all times. Restrict access when there is no adult supervision.
- No more than 2 children are allowed on the product at the same time. Combined weight of all users must not exceed 132lbs./60kg.
- Do not use the product in or around water. This is an electrically operated product and failure to follow these instructions could result in serious injury or death due to electric shock.
- Please ensure the openings of the enclosure netting are closed properly while children are bouncing inside the play house to avoid injuries from falling.
- Do not allow children to wrestle, flip or pile up on each other as this may result in serious injury. Separate the larger children from smaller children to avoid injuries while playing on the product.
- This product is for household and family domestic use only – It is not for use in schools, playgrounds, rental or commercial use.
- Always consult your physician before performing any kind of physical activity.
- Do not use or leave the product outside during windy conditions. Do not use if the user or the product surface is wet. These conditions can cause the user to lose control and fall resulting in serious injury.





### Before you start to assemble...

- Check the package and make sure you have all of the parts listed in the Parts List section of this user manual. IF ANY PARTS ARE MISSING, please call the Customer Service toll-free number listed on the cover page for assistance. Do not return to the store.
- Do not install or use the product if any parts are missing or damaged. Store in a safe place until ready to install.
- Mature adult required to assemble and disassemble the product.
- Make sure that you have plenty of space and a clean dry area suitable for the assembly of this product. IT IS ESSENTIAL THAT THE INTENDED SITE FOR THIS PRODUCT IS COMPLETELY FLAT AND LEVEL. If the ground is uneven, this could cause movement in the product that could result in property damage and/or cause serious injury.
- Place the inflatable device on level ground, not less than 1.8m (6ft) in any direction from any structure or obstruction such as a fence, garage, house, overhanging branches, laundry lines, or electrical wires.
- Never modify the construction or the design of the product. Do not use any unauthorized Sportspower parts.
- Carefully check the product and the surroundings before and during each use. Make sure the anchors are securely in place and the product is fully inflated before allowing children to play.
- **IMPORTANT:** Save this manual for future reference.

# Parts

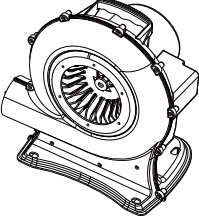
If you have damaged or missing parts,  
call the **Customer Helpline: (44)0330 0904 420**

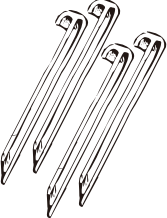
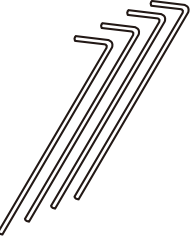
Please Check you have all the parts fittings listed below

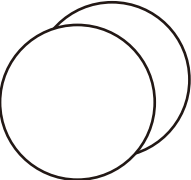
A	Blower		①
B	Bouncy Castle		①
C	Small Ground Anchors (for blower)		④
D	Steel Ground Anchors(for product)		④
E	Storage Case		①
F	Repair Kits		②

# Inflation & Anchoring

## Step 1

Remove the product from the storage case.

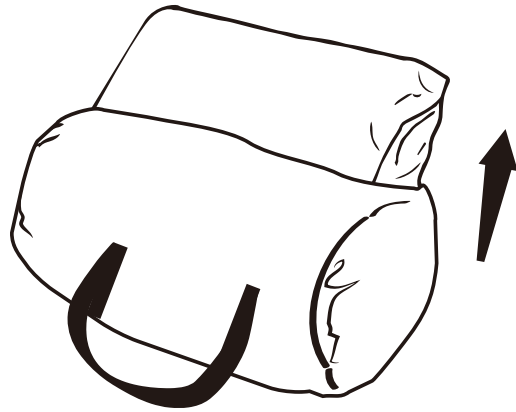

## Step 2

Unfold the product.



# Inflation & Anchoring

## Step 3

Tie the connector tube of the product to the blower.

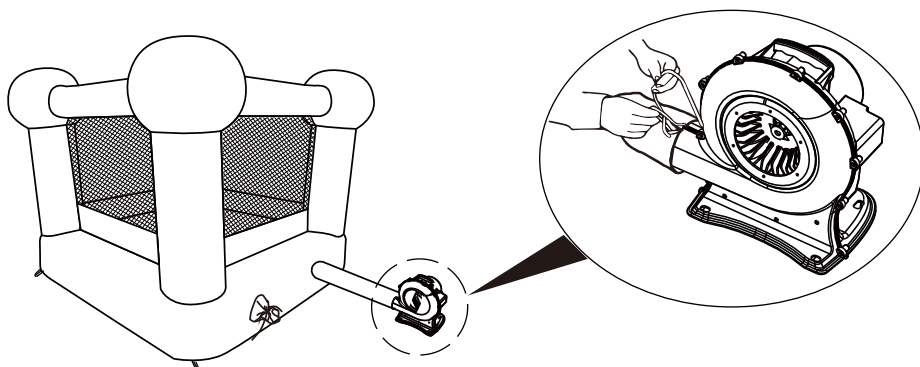

## Step 4

Fasten the rope to the short air outlet as shown.

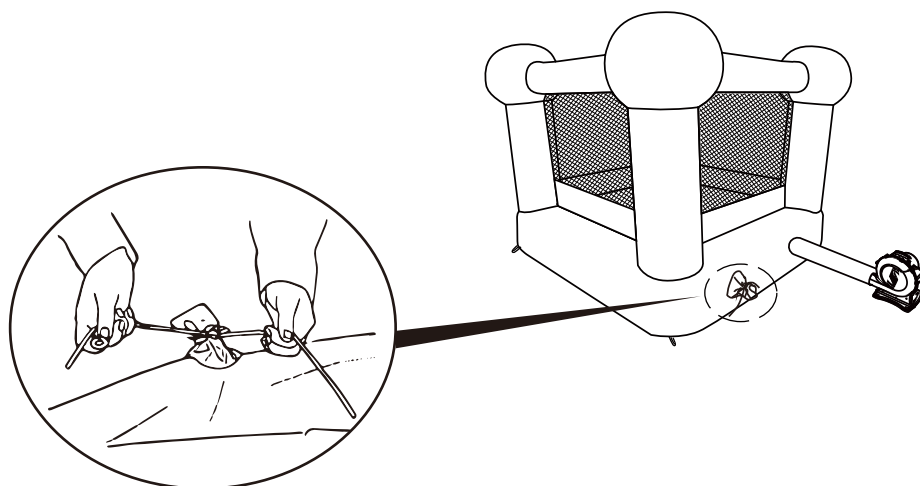



# Inflation & Anchoring

## Step 5

Secure the product and blower to the ground with the anchors provided.

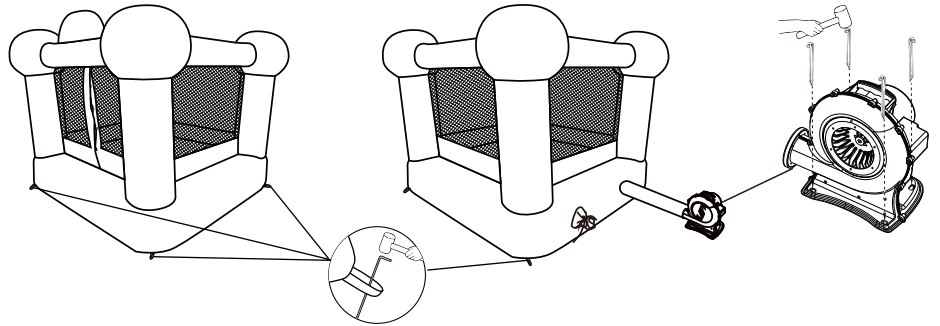

## Step 6

Switch blower power on. The product should inflate in approximately 2 minutes. Check for punctures if the product does not inflate properly. **IMPORTANT:** Blower should remain on to keep the product inflated during use.

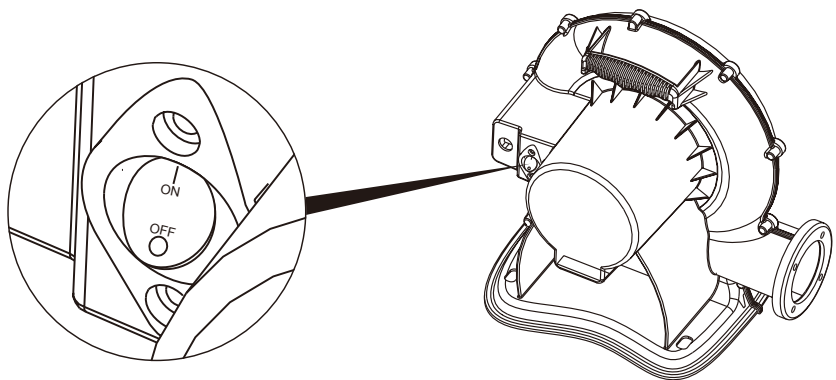

# Deflation & Stroage

## Step 1

Turn off the blower and unplug it from the outlet.

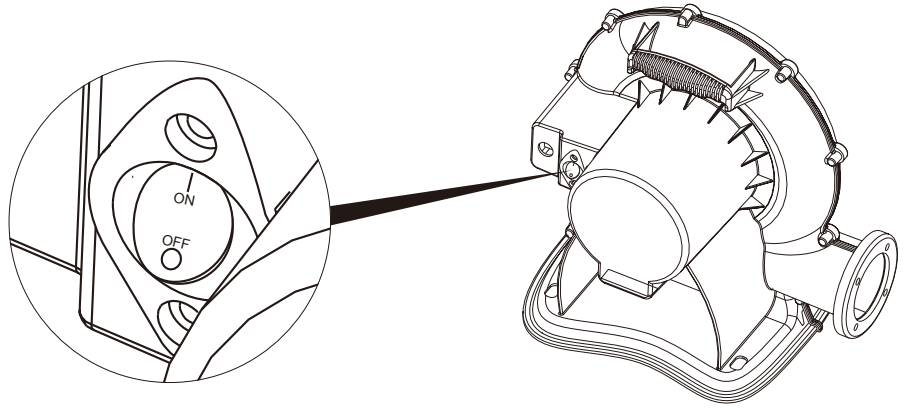

## Step 2

Remove the anchors from the ground, drawstring from the intake tube and allow the product to fully deflate.

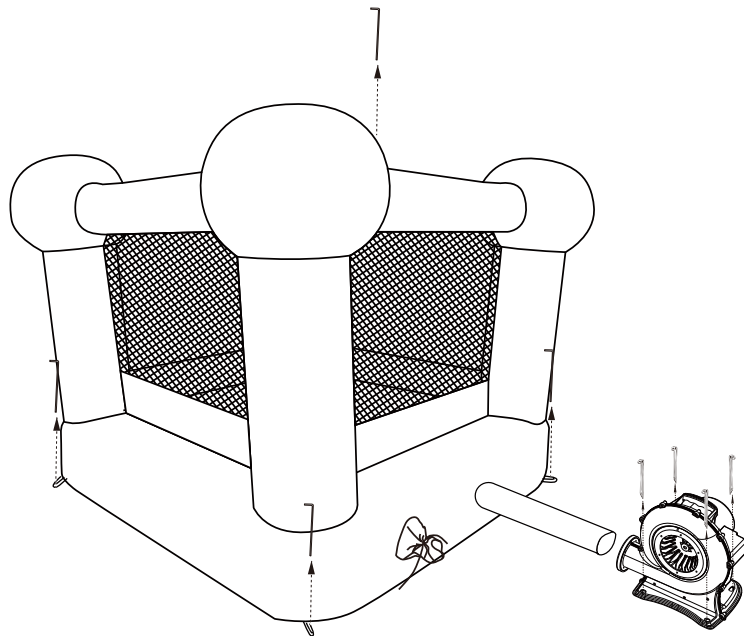

# Deflation & Stroage

## Step 3

Fold the product. Product must be completely dry before putting away for storage. Starting at one end, roll to force air out. If air remains inside, gently press it to deflate the air.

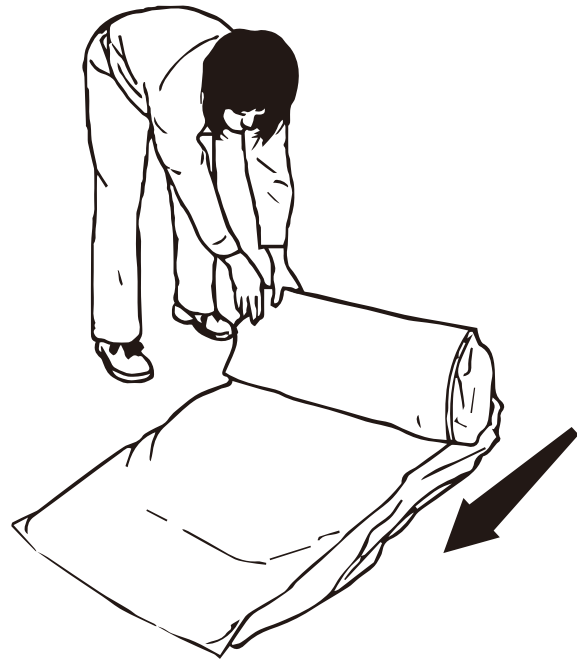

## Step 4

Place into the storage case.

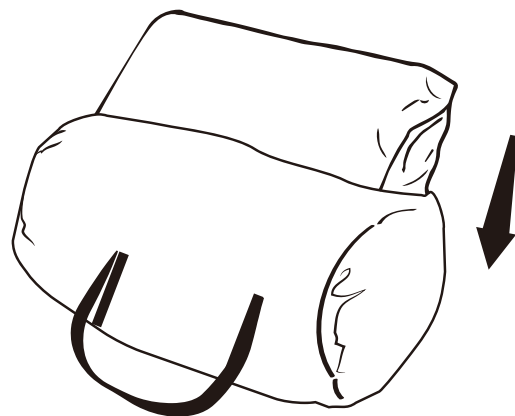

# Repair Instructions

- Identify the location of the puncture or leak.
- Deflate the product and gently clean the damaged area with a damp cloth. Allow area to dry thoroughly.
- Remove the adhesive backing from the repair patch and place it over the damaged area (cut to size if necessary).
- Press the repair patch to remove any air bubbles.
- Wait 30 minutes to allow the patch to dry before re-inflating.

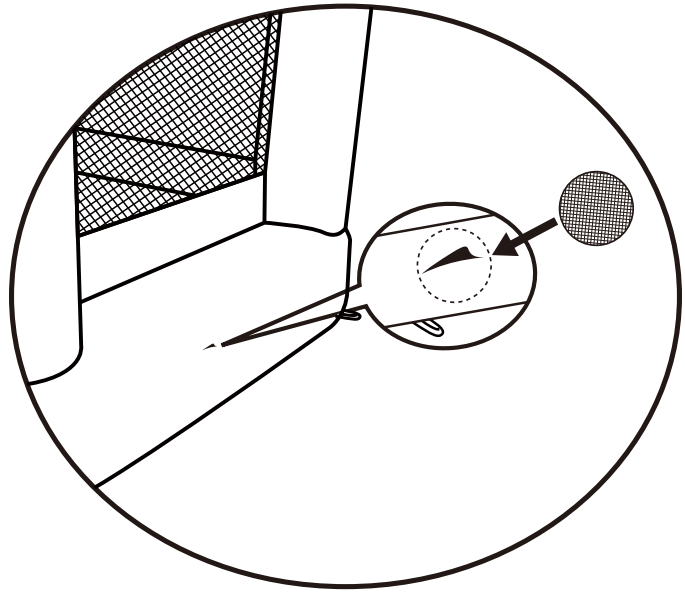

## **⚠ WARNING**

Warning: Repairs must only be made by adult(s).  
Keep repair kit away from children.

# Care And Maintenance

- Inspect the product and blower carefully before each use, making the anchors are fully secured and there are no tears or rips on the product.
- Do not use any chemicals or commercial cleaning products. Wipe clean with damp cloth.
- Product should be deflated, dried and stored immediately following use. Do not leave product exposed outdoors for extended periods as product will be damaged by external factors such as UV rays, rain and wind. In particular, do not leave outside during windy days.
- Make sure the product is fully dry before storing, and store only in a cool, well ventilated and dry location when not in use.
- Must be stored and kept out of reach of children and protected from pests or pets that can damage the product.
- Product must be fully inspected before and after each use. This is very important to ensure proper safety and maintenance of the product.

# Warranty Information

- Sportspower Ltd warrants its products to be free from defects in material and workmanship under normal use and service conditions for ninety (90) days after the date of purchase.
- All warranty coverage extends only to the original purchaser of the product and is not assignable or transferable. The original store or online purchase receipt must be kept as proof of purchase in order for the warranty to be valid. These documents must be presented in the event of making a claim under warranty.
- During the warranty period, Sportspower will provide repair or replacement of defective equipment or parts there of covered by the warranty. Any handling, transportation, delivery and other incidental charges in respect of the servicing of the equipment shall be borne by the Purchaser. If the product includes a number of accessories, only the defective part or accessory will be replaced.
- The warranty will become void if any defects or damages are associated with the use of unauthorized replacement parts. All replacement parts must be obtained from Sportspower authorized agents.
- All decisions made by Sportspower in respect of the servicing of the equipment (including repairs, replacements or issues relating to defects of workmanship or materials) shall be conclusive and the Purchaser agrees to be bound by such decisions. Any defective equipment or part thereof replaced shall become the property of Sportspower.
- In the event of a product or accessory being replaced during the guarantee, the guarantee on the replacement will expire at the original date, i.e. 90 days from the original purchase date.
- This warranty excludes defects caused by the product not being used in accordance with instructions, accidental damage, misuse or being tampered with by unauthorized persons.
- The sportspower limited warranty does not cover:
  - Products used for commercial or rental purposes.
  - Loss or damage to product due to: (i) abuse, repairs and/or tampering by any person other than the authorized personnel of sportspower; (ii) negligence and/or misuse (including foreign object, accident, improper storage, exposure to sun/moisture, excessive temperature, sand, dust, dirt, other pollution or other environmental conditions and failure to follow precautions or proper operating instructions stated in the user's manual such as improper installations); (iii) fire, flood, lightning strike, wind storm or other acts of god; (vi) freight or improper transport damages, and (v) improper usage (including use by under-age, over-weight or excessive number of users permitted as stated in the user's manual).
- Defects, damages or accidents due to the malfunction, connection to or use of non-sportspower or unauthorized parts. In such event, sportspower reserves the right to cancel the limited warranty coverage immediately.
- To the extent allowed by the applicable local law, the remedies in the limited warranty are the purchaser's sole and exclusive remedies.

# Warranty Information

- Sportspower is not responsible or liable for indirect, special or consequential damages arising out of or in connection with the use or performance of the product or other damages with respect to any economic loss, loss of property, loss of revenue or profits, loss of enjoyment or use, cost of removal, installation or other consequential damages. Some states do not allow the exclusion or limitation of incidental or consequential damages. Accordingly, the above limitation may not apply to you.
- The warranty extended hereunder is in lieu of all other warranties and any implied warranty of merchantability or fitness for a particular purpose is limited in its scope and duration to the terms set forth herein. Some states do not allow limitations on how long an implied warranty lasts. Accordingly, the above limitation may not apply to you. This warranty gives you specific legal rights. You may also have other rights which vary from state to state.

## **DO NOT RETURN TO THE STORE.**

These instructions contain important information which will help you get the best from your product and ensure safe and correct assembly, use and maintenance.

If you need help or have damaged or missing parts, call the Customer Helpline:  
(+44) 0330 0904 420

Sportspower Ltd - 20/F, PARKVIEW CENTRE, 7 LAU LI STREET, CAUSEWAY BAY, HONG KONG

**Produced for Chad Valley Toys, Argos Ltd.**

**Address: 489-499 Avebury Boulevard, Central Million Keynes, MK9 2NW. [www.argos.co.uk/chadvalley](http://www.argos.co.uk/chadvalley)**