

# SUMMER WAVES™ METAL FRAME POOL

FOR ABOVE GROUND SWIMMING POOLS

8'-24' (2.44m-7.32m) models



## READ, AND KEEP THESE INSTRUCTIONS FOR FUTURE REFERENCE

For any set up and troubleshooting issues, please visit

<https://polygroup.zendesk.com/hc/en-us> Customer Service: (888)919-0070

**DO NOT RETURN PRODUCT TO STORE**

To order parts and accessories,  
please visit [www.polygroupstore.com](http://www.polygroupstore.com)

Should you encounter a problem with your Polygroup® Product, please do not return the product to the place of purchase. All Warranty claims must be made directly to Polygroup®. Prior to contacting Customer Service, please first review the Troubleshooting Guide in the Installation Manual, or review the FAQ at [www.Polygroup.com](http://www.Polygroup.com). Please review setup instruction videos on [www.Polygroup.com/video](http://www.Polygroup.com/video). If you are still unable to correct the problem, please contact Polygroup® customer service at (888) 919-0070. Have the product type and your purchase receipt ready. Our Customer Service Representative will assist you in resolving the problem. You may be asked to return all or part of the product for inspection and/or repair. Do not return any product to Polygroup® without a Return Authorization number.

### LIMITED WARRANTY

Polygroup® Limited (Macao Commercial Offshore), (hereinafter "Polygroup®") warrants to the original purchaser only, the Metal Frame Pool against defects in material and workmanship for 90 days from the date of purchase. Original Purchaser must retain proof of such purchase in the form of an original store sales receipt and must produce such upon request by Polygroup® or its designated agents. Warranty claims cannot be processed without a valid proof of purchase. This Limited Warranty applies only to the original purchaser of the product and is limited solely to the repair or replacement of the product, to be decided in Polygroup®'s sole discretion. Consequential damages, including claims for loss of water, pool chemicals, damage, or labor are not covered under this Limited Warranty.

This Warranty will be declared invalid should the Purchaser modify or repair the product themselves or by unauthorized persons; use non-Polygroup® parts or accessories with the product; use the product in contravention of the manufacturer's Instructions; use improper voltage; abuse the product in any way; or through accident or negligence. Normal wear-and-tear is not covered under this Warranty, nor are acts of God outside the control of Polygroup®.

IN NO EVENT SHALL Polygroup®, THEIR AUTHORIZED AGENTS, RELATED ENTITIES, OR EMPLOYEES BE LIABLE TO THE BUYER OR ANY OTHER PARTY FOR DIRECT OR CONSEQUENTIAL DAMAGES. Some states or countries, or others jurisdictions do not allow the exclusion or limitation of incidental or consequential damages, so the above limitation or exclusion may not apply to you.

## TABLE OF CONTENTS

Warnings .....	3 ~ 6
Parts List .....	7
Setup Instructions .....	8 ~ 9
Pool Maintenance & Draining .....	10
Pool Storage & Winterizing .....	11
Pool Safety Sign .....	11
Pool Cover Safety.....	12

## IMPORTANT SAFETY INSTRUCTIONS

When installing and using this electrical equipment, basic safety precautions should always be followed, including the following:

### READ AND FOLLOW ALL INSTRUCTIONS

Keep for Future Reference. Failure to follow these warnings and instructions can result in serious injury or death to users, especially children.

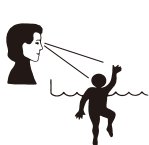

<b>⚠ DANGER</b>	
<b>PREVENT DROWNING</b>	<b>NO DIVING! NO JUMPING!</b>
Watch children at all times. Observe all Safety Rules.	Shallow Water - You can be permanently injured.

<b>⚠ WARNING</b>	
<b>DO NOT SIT ON OR LAY OVER POOL WALL</b>	<b>AVOID ENTRAPMENT</b>
You can be permanently injured.	Stay away from suction fittings. You may drown.



- Set up the pool only on **LEVEL, STABLE, and COMPACT** soil.
  - **DO NOT** set up the pool on sand surface.
  - **DO NOT** use sand to level the ground.
  - Sand can be washed out, causing the pool to **DEFORM** and **COLLAPSE**. Failure to comply may result in **PERSONAL INJURY**.
  - Excessive sand inside the pool will **DAMAGE** the pool liner and filtration system.
- Failure to follow these instructions will void the warranty.

**NOTICE:** CUSTOMERS THAT PURCHASE POOLS MAY BE REQUIRED BY LOCAL OR STATE LAW TO INCUR ADDITIONAL EXPENSES WHEN INSTALLING A POOL, IN ORDER TO COMPLY WITH STATE OR LOCAL LAWS REGARDING FENCING AND OTHER SAFETY REQUIREMENTS. CUSTOMERS SHOULD CONTACT THEIR LOCAL BUILDING CODE ENFORCEMENT OFFICE FOR FURTHER DETAILS.

## ⚠ WARNING

### Safety Care for Children

1. Children, especially children younger than five years, are at high risk of drowning. Drowning occurs silently and quickly and can occur in as little as 2in. (5cm) of water.
2. Keep children in your direct sight, stay close, and actively supervise them when they are in or near this pool and when you are filling and emptying this pool.
3. When searching for a missing child, check the pool first, even if the child is thought to be in the house.
4. Locate pumps and filters in such a way that children cannot climb on them and gain access to the pool.

### Swimming Pool Barriers

Very Important: Swimming pool barriers, which restrict access to the pool by small children, may be required by law. A barrier is necessary to provide protection against potential drowning and near drowning. Barriers are not a substitute for constant supervision of children. Check state or local laws and codes before setting up pool.

### Swimming Pool Equipment

1. The use of artificial pool lighting is at the discretion of the pool owner. Lighting, when installed, should be in accordance with Article 680 of the National Electrical Code (NEC) or its latest approved edition and in consultation with a licensed electrical professional.
2. Keep all electrical lines, radios, speakers, and other electrical appliances away from the pool.
3. Do not place pool near or under overhead electrical lines.
4. All electrical components installed in and/or adjacent to an aboveground/onground residential swimming pool shall be installed in accordance with and shall comply with the requirements of the latest published edition of NFPA 70, National Electrical Code (NEC®) Article 680, Swimming pools, fountains, and similar installations, and any state or local code.

Should you encounter any problems, contact Customer Service at (888) 919-0070 from 8 AM to 5 PM Mon. thru Fri.  
EST. Extended operating days and hours during peak season requirements.

## Swimming Pool Awareness

1. The pool is to be assembled by an adult; care should be taken in unpacking and assembling the pool; this pool may contain accessible potentially hazardous sharp edges or sharp points that are a necessary part of pool's the function.
2. If a drain or suction outlet cover is missing or broken, do not use the pool. Suction can cause body part entrapment, hair and jewelry entanglement, evisceration, or drowning. Repair or replace the drain or suction outlet cover before allowing the pool to be used.
3. During nighttime pool use, artificial lighting shall be used to illuminate all safety signs, ladders, steps, deck surfaces, and walks.
4. The floor of the pool shall be visible at all times from the outside perimeter of the pool.
5. Post a list of emergency telephone numbers such as the nearest available police, fire, ambulance, and/or rescue unit. These numbers are to be kept near the telephone, which is closest to the pool.
6. Basic lifesaving equipment, including one of the following, should be on hand at all times:
  - A light, strong, rigid pole (shepherds crook) not less than twelve feet (12') [366 cm] long.
  - A minimum one-fourth inch (1/4") [6.35 mm] diameter rope as long as one and one half (1-1/2) times the maximum width of the pool or fifty feet (50') [15.24 meters], whichever is less, which has been firmly attached to a Coast Guard-approved ring buoy having an outside diameter of approximately fifteen inches (15") [38.1 cm], or similarly approved flotation device.
7. The pool is subject to wear and deterioration. If not maintained properly, certain types of excessive or accelerated deterioration can lead to failure of the pool structure that might release large quantities of water that could cause bodily harm and property damage.
8. Never allow horseplay, diving, or jumping into or around the pool. Serious injury, paralysis, or death could result when this rule is disregarded.  
DO NOT ALLOW anyone to swim alone without supervision.
9. Keep your pool clean and clear. The deepest part of pool must be visible at all times from the outside barrier of the pool.
10. Pool shall be located at a minimum distance of 6ft (1.83m) from any receptacle, and all 125-volt 15- and 20-ampere receptacles located within 20ft (6.0m) of the pool shall be protected by a ground fault circuit interrupter (GFCI), where distances are by measuring the shortest path the supply cord of an appliance connected to the receptacle would follow, without piercing a floor, wall, ceiling, doorway with hinged or sliding door, window opening, or other effective permanent barrier, to the inside wall of the pool.

## Circulation Systems

1. Installers shall follow written instructions regarding positioning of all equipment connected to the circulation systems.
2. The installer shall follow written instructions provided for operating the circulation system components.
3. All circulation system components and pumps that require replacement or servicing shall be installed according to the pump's instruction manual.
4. Circulation equipment shall be installed per manufacturer's instructions to provide proper mounting and support, to prevent damage from misalignment, settlement, and vibration, and to minimize the potential for the accumulation of debris and moisture. Please refer to pump's instruction manual.

## Ladder

1. The ladder shall be located on a solid base, and the ladder shall be installed per the manufacturer's instructions.
2. One person on the ladder/stair at a time.
3. This ladder is designed and manufactured for a specific pool wall height and/or deck of the pool.
4. For entry/exit of pool, face the ladder at all times.
5. To prevent entrapment or drowning do not swim through, behind, or around ladder.
6. Remove and secure ladder when pool is not occupied.

## Pool Cover

Pool covers used for safety barriers shall comply with the latest published edition of ASTM F-1346, Standard performance specifications for safety covers and labeling requirements for all covers for swimming pools, spas, and hot tubs.

## Chemicals

For safety sake, ensure the deepest part of the pool is always visible. The user must properly maintain pool water clarity at all times. Check the pH and chlorine levels periodically, and make sure they are within the recommended limits. Additional water treatment chemicals might be needed from time to time. Have the water sample tested by a local pool supply store to determine if additional chemicals are needed. Turn on the filter pump system for at least six hours per day. Clean and replace filter cartridge frequently. Replace only with genuine Polygroup<sup>®</sup> / Summer Wave<sup>™</sup> Brand filter cartridge. Refer to the Filter Pump manual for additional water care information.

## Entrapment Risk

1. **Entrapment Avoidance:** There shall be no protrusions or other obstruction in the swimming area, which may cause entrapment or entanglement of the user.  
If a suction outlet cover is missing or broken, do not use the pool. Suction can cause body part entrapment, hair and jewelry entanglement, evisceration, or drowning. Repair or replace the suction outlet cover before allowing the pool to be used.
2. **DANGER! TO AVOID SERIOUS INJURY OR DEATH, CLOSE THE POOL OR SPA TO BATHERS IF ANY SUCTION OUTLET COVER/GRATE IS MISSING, BROKEN, OR INOPERATIVE.**
3. Never play or swim near drains or suction fittings. Your body or hair may be trapped, causing permanent injury or drowning.
4. Never enter the pool or spa if a suction fitting or drain cover is loose, broken, or missing.
5. Immediately notify the pool/spa owner or operator if you find a drain cover loose, broken, or missing.

## Drowning Risk

1. Keep unsupervised children from accessing the pool by installing fencing or other approved barrier around all sides of pool. State or local laws or codes may require fencing or other approved barriers. Check state or local laws and codes before setting up pool.
2. Remove pool ladders before leaving the pool. Children as young as 2 years have climbed up ladders and into pools and drowned.
3. Toys, chairs, tables, or similar objects that a young child could climb shall be at least four feet (4') [121.92 cm] from the pool. The pump filter system shall be positioned so as to prevent it from being used as a means of access to the pool by young children. Do not leave toys inside pool when finished using, since toys and similar items might attract a child to the pool.
4. Position furniture (for example: tables, chairs) away from pool and so that children cannot climb on it to gain access to the pool.
5. After using pool, remove water to a level of 1/2 in. (1 cm) or less.

## Diving Risk

1. Above ground / onground residential swimming pools are for swimming and wading only. No diving boards, slides, or other equipment are to be added to an above ground / onground pool that in any way indicates that an above ground / onground pool may be used or intended for diving or sliding purposes.
2. Do not dive into this pool. Diving into shallow water can result in a broken neck, paralysis, or death.

## Electrocution Risk

1. Keep all electrical lines, radios, speakers, and other electrical appliances away from the pool.
2. Do not place pool near or under overhead electrical lines.

## First Aid

1. Keep a working phone and a list of emergency numbers near the pool.
2. Become certified in cardiopulmonary resuscitation (CPR). In the event of an emergency, immediate use of CPR can make a lifesaving difference.

## Special Warning

1. Local building codes may require obtaining a building or electrical permit. Installer shall follow regulations on setback, barriers, devices, and other conditions.
2. Safety signs shall comply with requirements of ANSI-Z535 and use signal wording.
3. DO NOT attempt to assemble this pool in adverse weather conditions, windy conditions, or when the temperature is below 60°F.
4. This is a storable pool, which should be disassembled and stored when temperatures are expected to fall below 32°F.
5. The installer shall ensure that all pools and their related components that are installed in an indoor environment shall comply with the ventilation requirements of ANSI/ASHRAE62 or the latest published edition of Ventilation for acceptable indoor air quality, Table 2, Article 2.1.
6. The placement of the pool and portable pools shall be set up so that they comply with local safety and building codes.
7. **WARNING!** Competent supervision and knowledge of the safety requirements are the only way to prevent drowning or permanent injury in the use of this product! Never leave your children unattended.

## Pool Maintenance

1. Empty pool completely after each use, and store the empty pool in such a way that it does not collect water from rain or any other source.
2. After using pool, remove water to a level of 1/2in. (1cm) or less.

## Extra Safety Warning

1. Teach your children to swim.
2. Never dive, jump, or slide into the pool.
3. Adult supervision is always required.
4. Parents should learn CPR.
5. Never swim alone.
6. When you touch the filter, pump, or electrical parts, be sure the ground under your feet is "Bone Dry."
7. Connect power cords to a 3-wire grounding-type outlet only.
8. Keep all breakable objects out of the pool area.
9. Alcohol consumption and pool activities do not mix. Never allow anyone to swim, dive, or slide under the influence of alcohol or drugs.
10. Severe electrical shock could result if you install your pump or filter on a deck. The pump or filter could fall into the water, causing severe shock or electrocution.
11. Do not install on a deck or other surface at, above, or slightly below the top rail of the pool.
12. Do not use the pool during severe weather conditions, i.e. electrical storms, tornadoes, etc.
13. Be aware of overhead power lines when vacuuming your pool or using a telescoping pole.
14. Do not allow diving, climbing, sitting, or standing on the top rails of the pools.
15. Do not allow roughhousing and horseplay.
16. Do not engage in extended breath holding activities underwater; you may black out and drown.
17. Install a pool ladder(s) or staircase for entry and exit from the pool.
18. Keep deck clean and clear of objects that may create a tripping hazard.
19. Check regularly for signs of wear or loose bolts that could make the deck unsafe.
20. Instruct pool users about the proper use of all pool ladder(s) and staircases.

21. Face ladder going up or down.
22. Allow only one person at a time on the ladder.
23. Check all nuts and bolts regularly to ensure that the ladder stays sturdy.
24. Please contact pool site dealer or manufacturer for additional safety signs if deemed necessary.
25. For pool service, select a certified pool professional.

For additional safety information, see [www.APSP.org](http://www.APSP.org).

## Consumer Awareness Booklets and Information Source

**CONTACT:** U.S. Consumer Product Safety Commission at [www.CPSC.gov/cpsc/pub/pubs/pool/pdf](http://www.CPSC.gov/cpsc/pub/pubs/pool/pdf), Pub. #362 "Safety Barrier Guidelines for Home Pools."

1. The Sensible Way to Enjoy Your Aboveground/Onground Swimming Pool
2. Children Aren't Waterproof
3. Layers of Protection
4. Pool and Spa Emergency Procedures for Infants and Children
5. Be Safety Aware Copies of the above brochures are available free from the APSP. Go to: [www.APSP.org](http://www.APSP.org).

Safety Education Programs and Materials Educational programs and materials (i.e., seminars, workshops, brochures, videos, instructional guides) are available from the APSP, other aquatic safety groups, and by private firms. As a means of communicating useful safety information to pool owners/operators and users, industry members are permitted to provide such information to owners/operators and to request or require owners/operators to sign a statement that they have received, read, and will follow the guidelines.

### Other sources of safety information:

- [www.cdc.gov](http://www.cdc.gov)
- [www.cpsc.gov](http://www.cpsc.gov)
- [www.drowningpreventionalliance.com](http://www.drowningpreventionalliance.com)
- [www.nspf.org](http://www.nspf.org)
- [www.safekids.org](http://www.safekids.org)

### ANSI American National Standards Institute

25 West 43rd Street, New York NY 10036  
Contact: 212-642-4900  
[www.ansi.org](http://www.ansi.org)

### APSP Association of Pool & Spa Professionals

(formerly National Spa and Pool Institute)  
2111 Eisenhower Avenue, Alexandria VA 22314  
Contact: 703-838-0083  
[www.apsp.org](http://www.apsp.org)

### NSPI National Spa and Pool Institute (ss APSP)

#### UL Underwriters Laboratories

333 Pfingsten Road, Northbrook IL 60062-2096  
Contact: 847-272-8800  
[www.ul.com](http://www.ul.com)

### NSF NSF International

789 N. Dixboro Rd,  
P.O. Box 130140  
Ann Arbor MI 48113-0140  
734-769-8010  
[www.nsf.org](http://www.nsf.org)

### ASTM ASTM International (formerly American Society of Testing & Materials)

100 Barr Harbor Drive, West Conshohocken, PA 19428-2959  
Contact: 610-832-9585  
610-832-9555 (fax)  
[www.astm.org](http://www.astm.org)

### NEC National Electrical Code (see NFPA)

NFPA National Fire Protection Association  
1 Batterymarch Park, Quincy MA 02269  
Contact: 617-770-3000  
[www.nfpa.org](http://www.nfpa.org)

### ASME American Society of Mechanical Engineers

3 Park Avenue, New York NY 10016  
Contact: 212-591-8562  
[www.asme.org](http://www.asme.org)

## Filtration Systems

Any equipment connected to the circulation systems shall be positioned so as to prevent their being used as a means of access to the pool by young children. (See the latest published edition of ANSI/APSP-8 Model Barrier Code for Residential Swimming Pools, Spas, and Hot Tubs.)

## Barrier

Barrier is necessary to provide protection against potential drowning and near drowning, and barriers are not a substitute for the constant supervision of children. (See latest published edition of ANSI/APSP-8 Model Barrier Code for Residential Swimming Pools, Spas, and Hot Tubs.)







## Risk of Drowning, Entrapment, and Diving Accidents

Publications are available that describe the risk of drowning, entrapment, and diving accidents. Available publications related to pool safety include the Association of Pool and Spa Professionals' (APSP) booklets entitled: The Sensible Way to Enjoy Your Aboveground/ Onground Swimming Pool, Children Aren't Waterproof, Pool and Spa Emergency Procedures for Infants and Children, Layers of Protection, and the latest published edition of ANSI/APSP-8 Model Barrier Code for Residential Swimming Pools, Spas, and Hot Tubs.

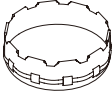
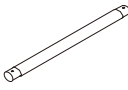
## Installer Responsibilities

All of these components shall be positioned so as to prevent their being used as a means of access to the pool by young children. (See the latest published edition of ANSI/APSP-8 Model Barrier Code for Residential Swimming Pools, Spas, and Hot Tubs.)

## PARTS LIST

	 1		 2		 3		 4		 5		 6		 7	
Metal Frame Pool	Pool Liner		Horizontal Beam		Vertical Leg		T-Fitting		Leg Cap		Pin & Grommet (with 2 extra)		Pre-installed V-Shape Spring Pin (w/1 extra)	
Pool Size	Part #	Qty.	Part #	Qty.	Part #	Qty.	Part #	Qty.	Part #	Qty.	Part #	Qty.	Part #	Qty.
10'x30"	P20010300099	x1	P5A1A0001W01	x10	P5A2A0001W01	x10	P5A3A0001W01	x10	P5APF1450K01	x10	P5A149144W01	x22	P5APF121BW01	x11
11'x30"	P20011300099	x1	P5A1A0001W01	x11	P5A2A0001W01	x11	P5A3A0002W01	x11	P5APF1450K01	x11	P5A149144W01	x24	P5APF121BW01	x12
12'x30"	P20012300099	x1	P5A1A0001W01	x12	P5A2A0001W01	x12	P5A3A0003W01	x12	P5APF1450K01	x12	P5A149144W01	x26	P5APF121BW01	x13
12'x36"	P20012360099	x1	P5A1A0001W01	x12	P5A2A0002W01	x12	P5A3A0003W01	x12	P5APF1450K01	x12	P5A149144W01	x26	P5APF121BW01	x13
12'x39"	P20012390099	x1	P5A1A0001W01	x12	P5A2A0003W01	x12	P5A3A0003W01	x12	P5APF1450K01	x12	P5A149144W01	x26	P5APF121BW01	x13
13'x30"	P20013300099	x1	P5A1A0001W01	x13	P5A2A0001W01	x13	P5A3A0001W01	x13	P5APF1450K01	x13	P5A149144W01	x28	P5APF121BW01	x14
13'x33"	P20013330099	x1	P5A1A0001W01	x13	P5A2A0010W01	x13	P5A3A0001W01	x13	P5APF1450K01	x13	P5A149144W01	x28	P5APF121BW01	x14
13'x39"	P20013390099	x1	P5A1A0001W01	x13	P5A2A0003W01	x13	P5A3A0001W01	x13	P5APF1450K01	x13	P5A149144W01	x28	P5APF121BW01	x14
14'x36"	P20014360099	x1	P5A1A0002W01	x14	P5A2A0004W01	x14	P5A3A0004W01	x14	P5APF0490K01	x14	P5A120144W01	x30	P5APF121AW01	x15
14'x42"	P20014420099	x1	P5A1A0002W01	x14	P5A2A0005W01	x14	P5A3A0004W01	x14	P5APF0490K01	x14	P5A120144W01	x30	P5APF121AW01	x15
14'x52"	P20014520099	x1	P5A1A0002W01	x14	P5A2A0006W01	x14	P5A3A0004W01	x14	P5APF0490K01	x14	P5A120144W01	x30	P5APF121AW01	x15
15'x33"	P20015330099	x1	P5A1A0002W01	x15	P5A2A0012W01	x15	P5A3A0005W01	x15	P5APF0490K01	x15	P5A120144W01	x32	P5APF121AW01	x16
15'x42"	P20015420099	x1	P5A1A0002W01	x15	P5A2A0007W01	x15	P5A3A0005W01	x15	P5APF0490K01	x15	P5A120144W01	x32	P5APF121AW01	x16
15'x46"	P20015460099	x1	P5A1A0002W01	x15	P5A2A0011W01	x15	P5A3A0005W01	x15	P5APF0490K01	x15	P5A120144W01	x32	P5APF121AW01	x16
15'x48"	P20015480099	x1	P5A1A0002W01	x15	P5A2A0008W01	x15	P5A3A0005W01	x15	P5APF0490K01	x15	P5A120144W01	x32	P5APF121AW01	x16
15'x52"	P20015520099	x1	P5A1A0002W01	x15	P5A2A0009W01	x15	P5A3A0005W01	x15	P5APF0490K01	x15	P5A120144W01	x32	P5APF121AW01	x16
16'x42"	P20016420099	x1	P5A1A0002W01	x16	P5A2A0007W01	x16	P5A3A0006W01	x16	P5APF0490K01	x16	P5A120144W01	x34	P5APF121AW01	x17
16'x48"	P20016480099	x1	P5A1A0002W01	x16	P5A2A0008W01	x16	P5A3A0006W01	x16	P5APF0490K01	x16	P5A120144W01	x34	P5APF121AW01	x17
16'x52"	P20016520099	x1	P5A1A0002W01	x16	P5A2A0009W01	x16	P5A3A0006W01	x16	P5APF0490K01	x16	P5A120144W01	x34	P5APF121AW01	x17
17'x48"	P20017480099	x1	P5A1A0002W01	x17	P5A2A0008W01	x17	P5A3A0007W01	x17	P5APF0490K01	x17	P5A120144W01	x36	P5APF121AW01	x18
17'x52"	P20017520099	x1	P5A1A0002W01	x17	P5A2A0009W01	x17	P5A3A0007W01	x17	P5APF0490K01	x17	P5A120144W01	x36	P5APF121AW01	x18
18'x42"	P20018420099	x1	P5A1A0002W01	x18	P5A2A0007W01	x18	P5A3A0008W01	x18	P5APF0490K01	x18	P5A120144W01	x38	P5APF121AW01	x19
18'x48"	P20018480099	x1	P5A1A0002W01	x18	P5A2A0008W01	x18	P5A3A0008W01	x18	P5APF0490K01	x18	P5A120144W01	x38	P5APF121AW01	x19
18'x52"	P20018520099	x1	P5A1A0002W01	x18	P5A2A0009W01	x18	P5A3A0008W01	x18	P5APF0490K01	x18	P5A120144W01	x38	P5APF121AW01	x19
20'x48"	P20020480099	x1	P5A1A0002W01	x20	P5A2A0008W01	x20	P5A3A0009W01	x20	P5APF0490K01	x20	P5A120144W01	x42	P5APF121AW01	x21
24'x48"	P20024480099	x1	P5A1A0002W01	x24	P5A2A0008W01	x24	P5A3A0010W01	x24	P5APF0490K01	x24	P5A120144W01	x50	P5APF121AW01	x25
24'x52"	P20024520099	x1	P5A1A0002W01	x24	P5A2A0009W01	x24	P5A3A0010W01	x24	P5APF0490K01	x24	P5A120144W01	x50	P5APF121AW01	x25

Should you encounter any problems, contact Customer Service at (888) 919-0070 from 8 AM to 5 PM Mon. thru Fri.  
EST. Extended operating days and hours during peak season requirements.

# SETUP INSTRUCTIONS

Before assembling your product, please take a few minutes to check the contents and become familiar with all the parts.

**⚠ WARNING** - DO NOT overfill the pool and / or allow people to lay over or sit on pool wall - DOING SO CAN CAUSE PERMANENT INJURY!  
DRAIN pool to the proper level after a heavy rain.

**TIP:** It will be much easier to install your pool if you unfold it and let it lay in direct sunlight for about 2 hours prior to installation. This will help to insure a wrinkle-free fit because the pool material will be more pliable allowing it to form into shape during installation.

**WARNING** - VERY IMPORTANT! SITE MUST BE LEVEL, STABLE, COMPACTED SOIL.

- The pool must be assembled on a smooth and level site of firm soil that is free of stones, gravel, sticks, blacktop, or other oil base compounds. Do not install pool on a wooden deck or any type of wooden surface. You cannot use sand and/or uncompacted soil to provide a level surface for this pool; it will only wash out.
- FAILURE TO FOLLOW THE INSTRUCTIONS BELOW WILL CAUSE POOL TO COLLAPSE AND WILL VOID THE WARRANTY!

1. Select a level area, and completely remove all debris, twigs, stones, etc. DO NOT select an area under overhead electrical lines, trees, or within 15 feet of a house, building, etc.
2. The pool shall be located a minimum distance of 6ft (1.83m) from any electrical receptacle.
3. All 125 volt, 15 and 20 ampere receptacles located within 20ft (6.0m) of the pool shall be protected by a ground fault circuit interrupter (GFCI).  
The 20ft (6m) distance is measured via the shortest straight line distance the supply cord would follow without piercing a floor, wall, ceiling, doorway, window, or other permanent barrier.
4. Contact your local utilities, checking that no underground cables, telephone lines, gas lines, etc. run beneath the area you have selected.

## Setup Instructions

1. Locate a level and flat area to set up the pool. Make sure the ground is free from sharp objects, as they may puncture the pool.
2. LIFT the pool liner across the ground. DO NOT drag the liner from one location to another location.
3. Locate the pool so that the pump opening is 10 to 21 feet away from the electrical outlet.

4. Put on the Vertical Leg **3** in each Leg Cap **5**.

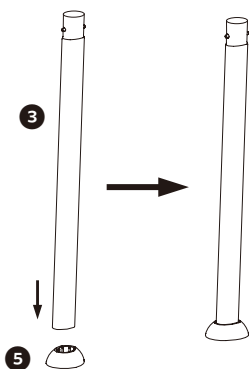

5. Lay down all parts on the ground as shown below.

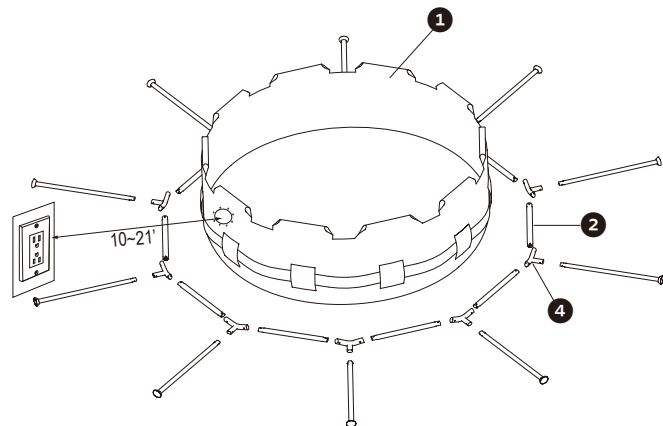



6. Carefully slide the Horizontal Beams **2** into the sleeves of the pool.

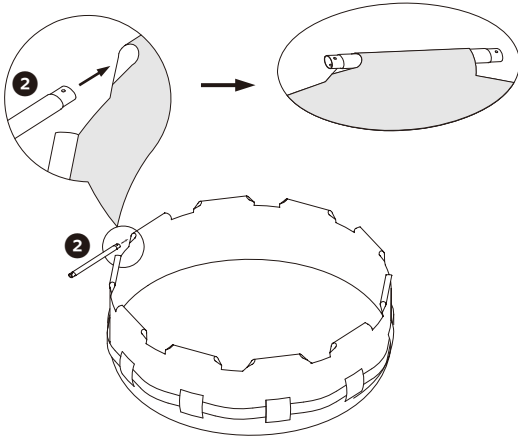

7. Connect the T-Fitting **4** to Horizontal Beam **2**

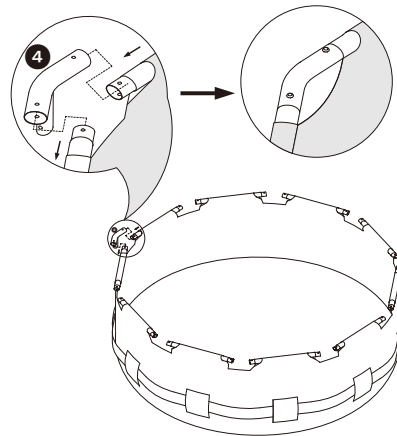

8. Insert the Pin **6** down through the top of the T-Fittings until the Pin snaps into place on the lower side of the fitting.

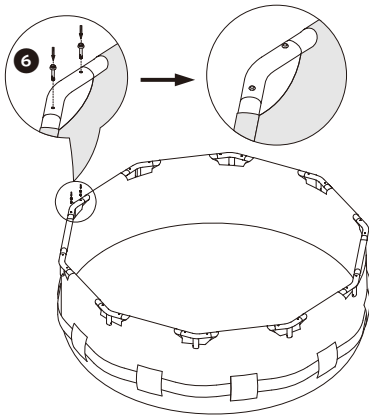

9. Carefully slide the Vertical Leg **3** down through the belt that runs around the middle of the pool.

- For smaller pools without a belt, slide the vertical leg through the sleeves on the pool wall.

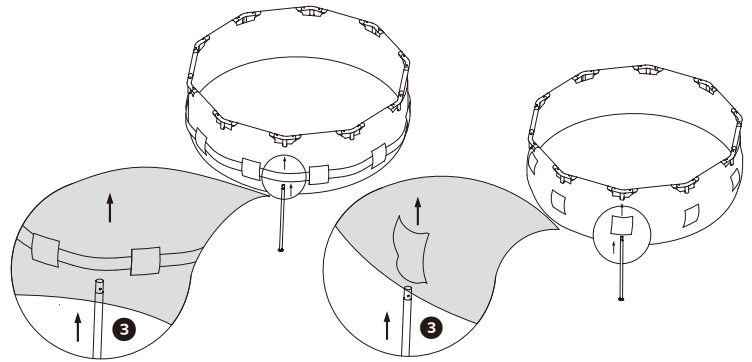

10. Look through the hole in the fitting as you insert and rotate the pipe until the buttons align with the holes and pop out, locking the leg in place.

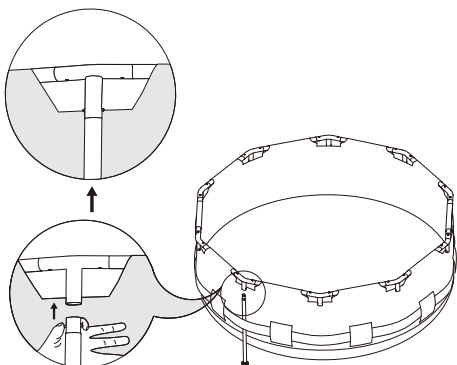

11. Go around and check all fittings, legs, and beams are properly installed and secured in place. Make sure the drain fitting is plugged securely and the cap is in place.

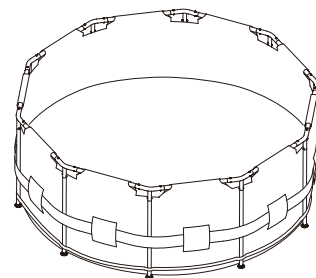

12. Start filling the pool with water until 1-inch of water is on the bottom; then, stop filling and smooth wrinkles out of the pool bottom. Push outward from inside the pool removing all wrinkles so that it fills evenly and flat. IF MORE THAN 1-2 INCHES OF WATER COLLECTS ON ANY ONE SIDE BEFORE THE POOL STARTS FILLING IN THE CENTER, THE POOL IS NOT LEVEL ENOUGH, AND MUST BE CORRECTED.

## POOL MAINTENANCE & DRAINAGE

**CAUTION:** ALWAYS FOLLOW THE CHEMICAL MANUFACTURER'S DIRECTIONS, AND THE HEALTH AND HAZARD WARNINGS.

Do not add chemicals if the pool is occupied. This can cause skin or eye irritation. Concentrated chlorine solutions can damage the pool liner. In no event is Polygroup®, the buyer, or any other party liable for costs associated with the loss of pool water, chemicals, or water damage. Keep spare filter cartridges on hand. Replace cartridges every two weeks. We recommend the use of Polygroup® Filter Pump with all of our above-ground-pools. To purchase a Polygroup® Filter Pump or other accessories, visit our website or call Polygroup® Consumer Services.

**EXCESSIVE RAIN:** To avoid damage to the pool and over filling, immediately drain rain water that causes the water level to be higher than the maximum.

### How to Drain Your Pool and Long Term Storage

1. Check local regulations for specific directions regarding disposal of swimming pool water.
2. Check to make sure that the drain plug inside the pool is plugged in place.
3. Remove the cap from the drain valve on the outside pool wall.
4. Place the other end of the hose in an area where the water can be safely drained away from the house and other nearby structures.
5. When the water stops draining, start lifting the pool from the side opposite the drain, leading any remaining water to the drain and emptying the pool completely.
6. Disconnect hose and adapter when finished.
7. Re-insert drain plug in drain valve on inside of pool for storage.
8. Replace drain cap on outside of pool.
9. Completely deflate the top ring, and remove all connecting parts.
10. Be sure that the pool and all parts are completely dry before storage. Air dry the liner in the sun until completely dry before folding (see drawing ①). Sprinkle some talcum powder to prevent the vinyl from sticking together and to absorb any residual moisture.
11. Create a square shape. Starting at one side, fold one-sixth of liner into itself twice. Do the same on the opposite side (see drawings ② & ③).
12. Once you have created two opposing folded sides, simply fold one over the other like closing a book (see drawings ④ & ⑤).
13. Fold the two long ends to the middle (see drawing ⑥).
14. Fold one over the other like closing a book, and finally compact the liner (see drawing ⑦).
15. Store the liner and accessories in a dry, temperature controlled storage location, between 32 degrees Fahrenheit (0 degrees Celsius) and 104 degrees Fahrenheit (40 degrees Celsius).
16. The original packing can be used for storage.

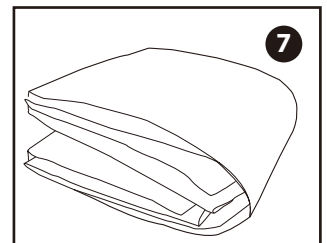
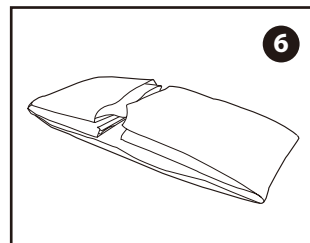
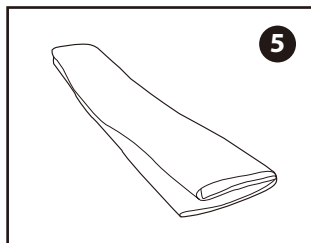
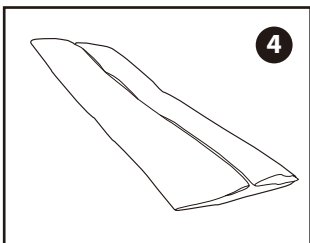
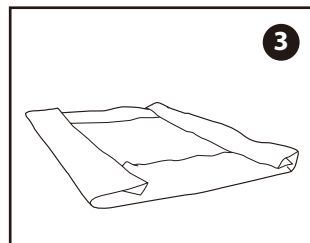
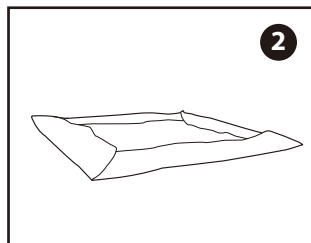
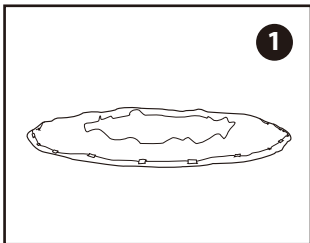

## POOL STORAGE & WINTERIZING

### Winterizing Your Above Ground Pool

After usage, you can easily empty and store away your pool in a safe place. Some pool owners, however, choose to leave their pool up all year round. In cold areas, where freezing temperatures occur, there can be a risk of ice damage to your pool. We therefore recommend you drain, disassemble, and properly store the pool, when the temperature drops below 32 degrees Fahrenheit (0 degrees Celsius).

### Clean the Pool Water Thoroughly

1. Clean the pool water thoroughly. If the type is a Quick Set Pool, make sure that the top ring is properly inflated.
2. Remove the skimmer (if applicable) or any accessories attached to the threaded strainer connector. Replace strainer grid if necessary. Be sure all accessories parts are clean and completely dry before storage.
3. Plug the Inlet and Outlet fitting from the inside of the pool with the plug provided (sizes 16' and below). Close the Inlet and Outlet Plunger Valve (sizes 17' and above).
4. Remove the ladder (if applicable) and store in a safe place. Be sure the ladder is completely dry before storage.
5. Remove the hoses that connect the pump and filter to the pool.
6. Add the appropriate chemicals for the winter period. Consult your local pool dealer as to which chemicals you should use and how to use them. This can vary greatly by region.
7. Cover pool with Polygroup® Pool Cover. IMPORTANT NOTE: Polygroup® POOL COVER IS NOT A SAFETY COVER.
8. Clean and drain the pump, filter housing, and hoses. Remove and discard the old filter cartridge. Keep a spare cartridge for the next season.
9. Bring pump and filter parts indoors and store in a safe and dry area, preferably between 32 degrees Fahrenheit (0 degrees Celsius) and 104 degrees Fahrenheit (40 degrees Celsius).

## POOL SAFETY SIGN

POST THIS WARNING NEAR YOUR POOL

# WARNING

## NO DIVING OR JUMPING SHALLOW WATER

**DIVING MAY RESULT IN PERMANENT INJURY OR DEATH**

- Be Safe. Swim with a friend.
- Children must be accompanied by an adult.
- Don't swim when using alcohol or drugs.
- Be familiar with the pool before swimming.
- No running, jumping, or horseplay in or around pool.
- No glass in pool area.

**TO AVOID SERIOUS INJURY ALL POOL USERS MUST KNOW AND FOLLOW THESE SAFETY RULES.**

## POOL COVER SAFETY

IF YOU ARE GOING TO USE A POOL COVER, SOLAR COVER, OR SOLAR BLANKET, PLEASE READ THIS INFORMATION.

### POOL COVER WARNING SOLAR COVER WARNING

#### **WARNING**

##### **AVOID DROWNING RISK**

STAY OFF COVER - WILL NOT SUPPORT WEIGHT.

KEEP CHILDREN AWAY. CHILDREN OR OBJECTS CAN NOT BE SEEN UNDER COVER.

REMOVE STANDING WATER - CHILD CAN DROWN ON TOP OF COVER.

REMOVE COVER COMPLETELY BEFORE ENTRY OF BATHERS - ENTRAPMENT POSSIBLE.

NON-SECURED OR IMPROPERLY SECURED COVERS ARE A HAZARD.

FAILURE TO FOLLOW ALL INSTRUCTIONS MAY RESULT IN INJURY OR DROWNING.

THIS IS NOT A SAFETY COVER.

TYPE OC COVER CLASSIFICATION.

INSTALL COVER WITH LABELS FACING UP.

USE DRAWSTRING TO SECURE COVER TO POOL.

THIS COVER MEETS REQUIREMENTS DESCRIBED IN SPECIFICATION F-1346 (ASTM).

### SOLAR BLANKET WARNING

#### **WARNING**

##### **AVOID DROWNING RISK**

STAY OFF COVER - WILL NOT SUPPORT WEIGHT.

KEEP CHILDREN AWAY. CHILDREN OR OBJECTS CAN NOT BE SEEN UNDER COVER.

REMOVE STANDING WATER - CHILD CAN DROWN ON TOP OF COVER.

REMOVE COVER COMPLETELY BEFORE ENTRY OF BATHERS - ENTRAPMENT POSSIBLE.

NON-SECURED OR IMPROPERLY SECURED COVERS ARE A HAZARD.

FAILURE TO FOLLOW ALL INSTRUCTIONS MAY RESULT IN INJURY OR DROWNING.

THIS IS NOT A SAFETY COVER.

TYPE OC COVER CLASSIFICATION.

INSTALL COVER WITH LABELS FACING UP.

USE DRAWSTRING TO SECURE COVER TO POOL.

THIS COVER MEETS REQUIREMENTS DESCRIBED IN SPECIFICATION F-1346 (ASTM).

## VERY IMPORTANT

DO NOT USE A POOL COVER, SOLAR COVER, OR SOLAR BLANKET ON THIS POOL IF IT DOES NOT HAVE THIS TYPE OF WARNING LABEL ON THE COVER.

## DANGER:

Competent supervision and knowledge of the safety requirements are the only ways to prevent drowning or permanent injury in the use of this product!

Never leave young children unattended.