

**Chad
Valley**[®]

Nursery swing

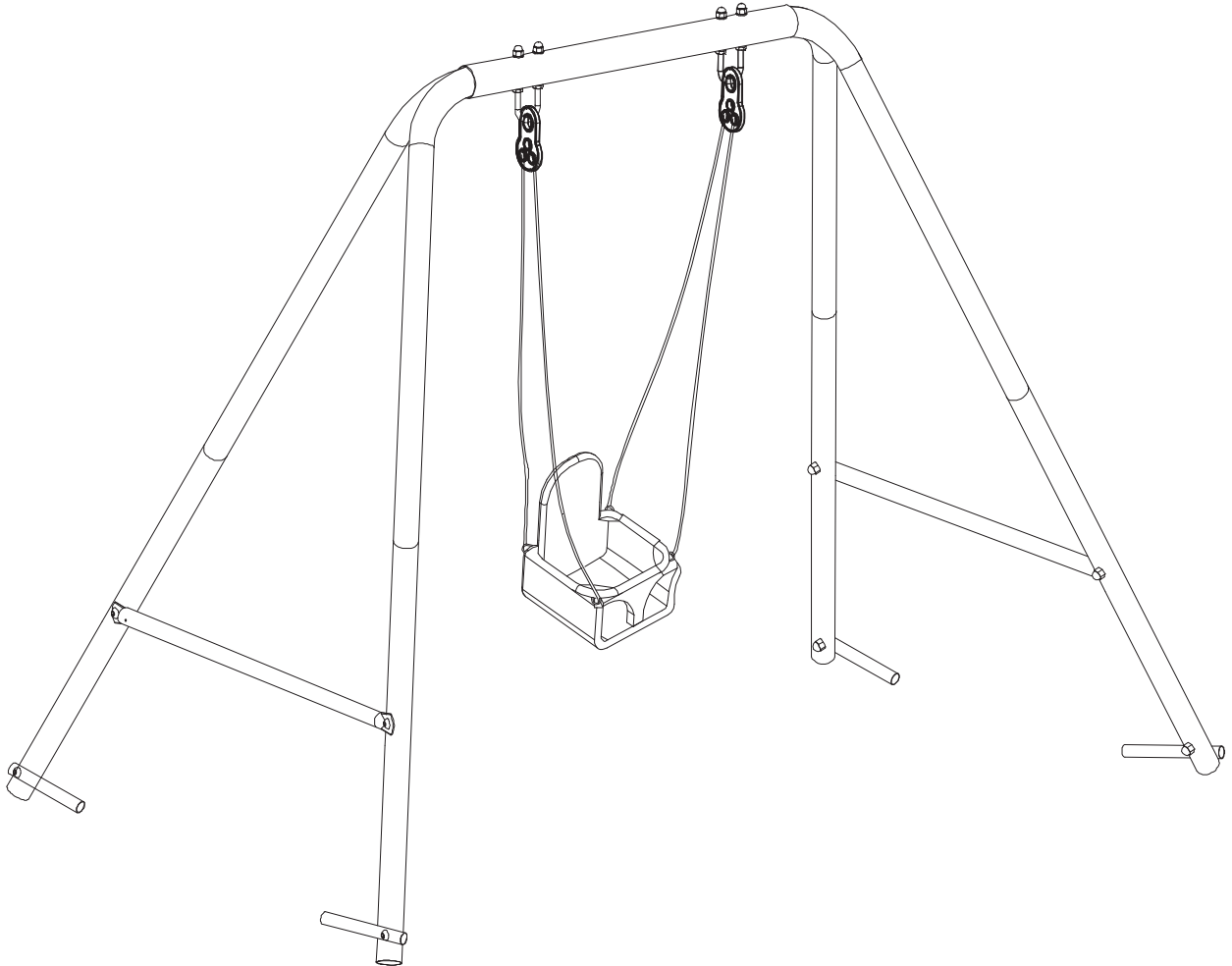

Important

**Age: 12 – 36
months.**

**Maximum user
weight: 25kg**

Assembly

**Tips: It will take around 30
minutes to assemble.**

2 Adults required

Assembly & User Instructions - Please keep for future reference

**7942336
7997862**

Important - Please read these instructions fully before assembly or use.

These instructions contain important information which will help you get the best from your product and ensure safe and correct assembly, use and maintenance.

If you need help or have damaged or missing parts, call the **Customer Helpline: (+44) 0330 0904 420**

Contents

Safety Information	2
Parts	3
Assembly Instructions	4-8
Care and Maintenance	9

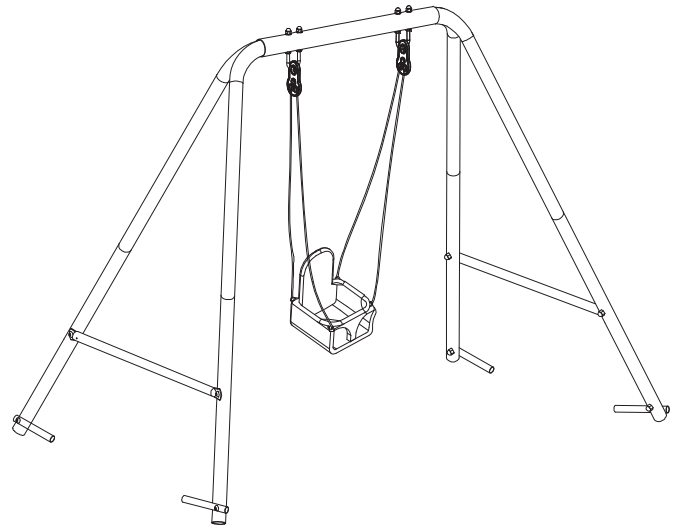



Safety Information

Important –Please read these instructions fully before assembly or use.



WARNING

1. This swing is for domestic family use only and is intended for outdoor use.
2. This swing is designed for children between the ages of 12 – 36 months.
3. Max weight of user shall not exceed 25kg.
4. For use under adult supervision.
5. Do not orientate the swing directly towards the sun this may lead to a child becoming dizzy/disorientated through extended use.
6. Do not install the product on concrete, asphalt or hard surfaces.
7. Do not allow children to stand on the swing seat.
8. Do not allow children to get off of the swing whilst it is still moving.
9. Do not twist swing ropes or wrap them over the top cross beam.
10. Do not allow children to use the item if they are wearing loose, hooded or baggy clothing. Clothing can get caught leading to user injury.
11. Do not allow children to climb on the swing. The swing should be sat upon with the child's body weight centrally in the seat.
12. Do not allow children to wander into the play area when the swing is in use.
13. Place the swing on a level surface at least 2 metres from any structures or obstructions such as a fence, garage, house, overhanging branches, laundry lines or electrical wires etc.
14. Children should be instructed by a parent or an accompanying adult NOT to attach items to the swing that are not specifically designed for use with it, such as, but not limited to, jump ropes, clothes lines, pet leashes, chains and cables. This all could cause a strangulation hazard.
15. Packing materials are not toys. Please remove and all packaging and packing materials before letting children use this swing.
16. Required at least 2 adults for assembly.
17. Only one child per seat at any one time.
18. Check all nuts, bolts and fittings for tightness and tighten if required.
19. Check all coverings for bolts and sharp edges and replace when required.
20. Oil all metallic moving parts.
21. Check swing seats, ropes and other means of attachments for evidence of deterioration. Replace when required in accordance with the manufacture's instructions.
22. Please take note: As an extra precaution, check this toy regularly for signs of wear and damage.
23. For safety reasons, this swing **MUST** be anchored into the ground.
24. Anchors shall be placed level with or under the ground in order to reduce the risk of tripping.
25. Leave all fittings finger-tight until assembly is complete, for ease of construction. Then tighten firmly.
26. Swing must not exceed an angle of 60 degrees from the ground.
27. Failure to assemble and maintain this item as per these instructions may cause injury to the user.
28. Maintenance to be carried out under the direct supervision of a responsible adult.
29. Check and maintenance of the main parts(crossbeams, suspensions, anchors, ETC) at regular intervals. If these checks are not carried out, the toy could overturn or otherwise become a hazard.
30. Changes to the original toy (for example the adding of an accessory) shall be carried out according to the instructions of the original toy.
31. Once assembly is complete, carefully check the equipment before use. If you find any problems, do not allow children to use the equipment until it is fit for use.
32. Please retain these instructions for future reference.
33. Warning! only for domestic use.

Parts

If you have damaged or missing parts,
call the **Customer Helpline: (+44) 0330 0904 420**

Please Check you have all the parts fittings listed below

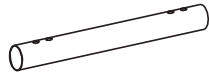

1 Beam x 1pcs

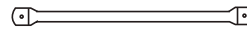

5 Rail x 2pcs



2 Leg x 2pcs

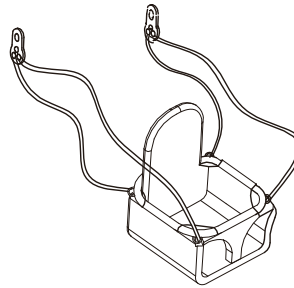

6 Nursery seat x 1pcs



3 Leg x 2pcs

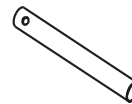

7 Anchor x4pcs



4 Leg x 4pcs



8 Plastic Cap x4pcs

Note: The quantities below are the correct amount to complete the assembly. In some cases more fittings may be supplied than are required.

A x2 (M8)		B x4 (M6x38mm)		C x4 (M6x53mm)		D x4 (M6x42mm)	
E x8 (Ø19xØ8.5mm)		F x24 (Ø14xØ6.5mm)		G x4 (Ø13.5xØ8.5mm)		H x12 (Ø10xØ6.5mm)	
I x4 (M8)		J x12 (M6)		K x1 (10 & 13mm)		L x1 (4mm)	

Ruler - Use this ruler to help correctly identify the bolts/screws

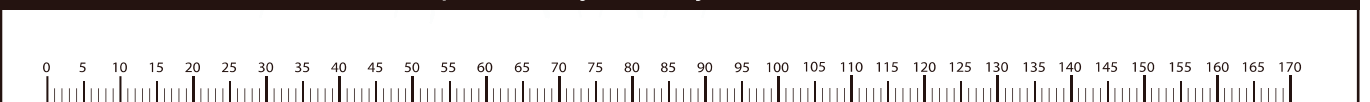

Assembly Instructions

Step 1

Insert Legs (2) and (3) into Beam (1) as shown.

Please note the order of Legs (2) and (3) need to be inverse on the two sides of the beam.

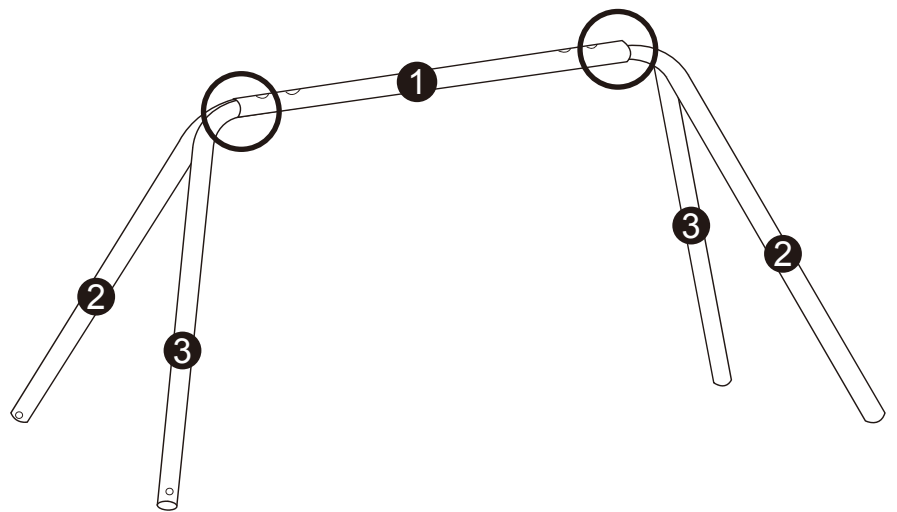
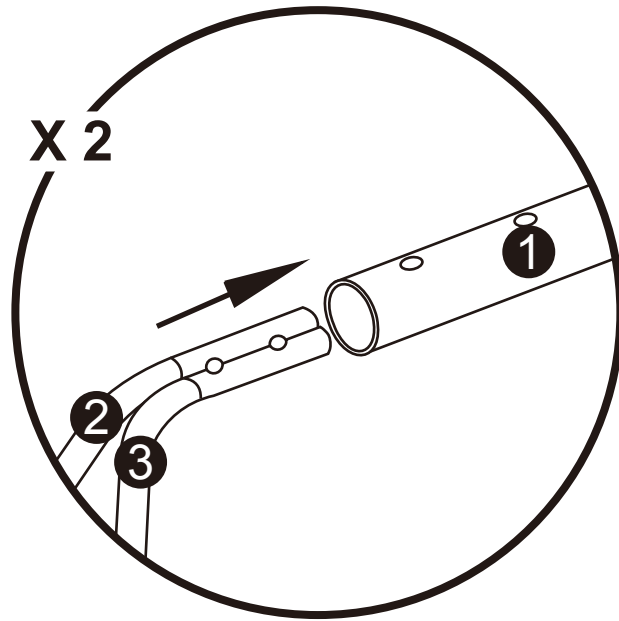



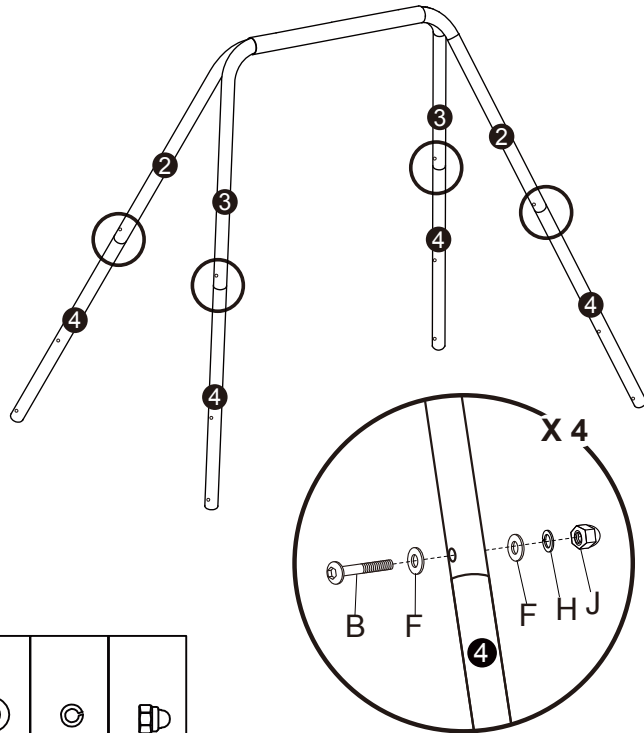

Assembly Instructions

Step 2

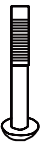
Insert leg(4) into leg(2) and leg(3) on both sides. Secure using bolt(B), flat spring(F), spring washer(H) and nuts(J).



			
B	F	H	J
x4 pcs	x8 pcs	x4 pcs	x4 pcs





Step 3

Attach rail(5) to leg(4) on both sides using bolt(D), flat washer(F), spring washer(H) and nuts(J).

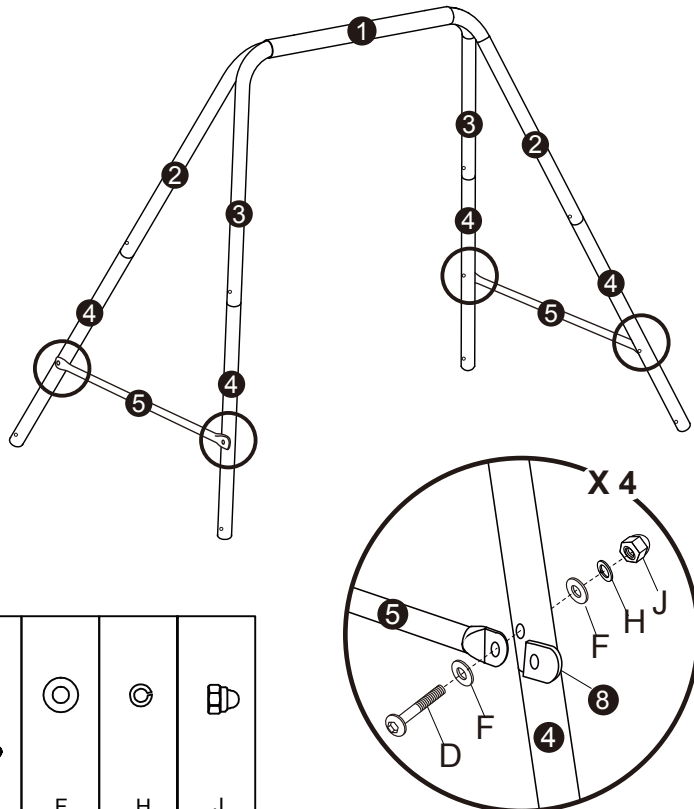
TIPS:

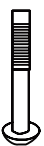
- #1 Make sure you insert plastic cap (8) into rail (5) first.
- #2 The rail (5) need to be attached to the outer side of the swing frame.







			
D	F	H	J
x4 pcs	x8 pcs	x4 pcs	x4 pcs

Assembly Instructions

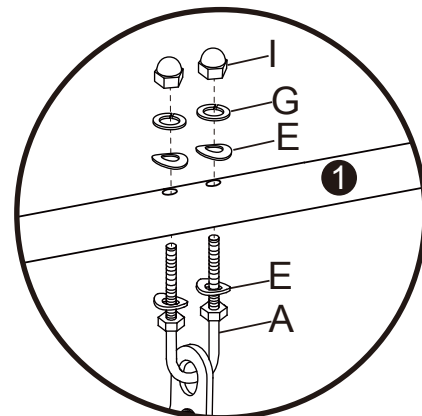
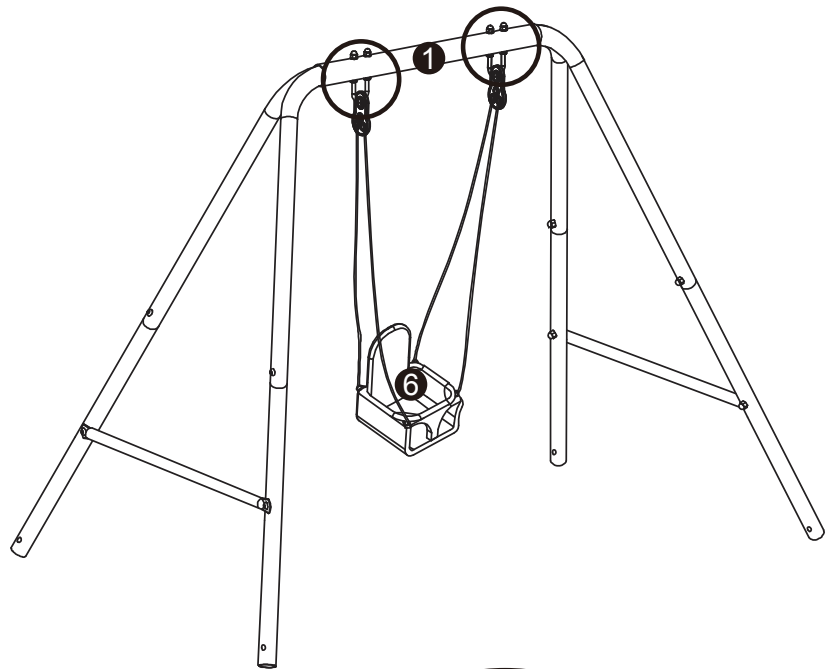
Step 4

Loop U-bolt (A) through the plate at the top of the swing and secure it to Beam (1) using E, G and I in the sequence as shown.



			
x2	x8	x4	x4
A	E	G	I

Assembly Instructions

Step 5

Attach anchor(7) to the bottom of leg(4), using bolt(C), flat spring(F), spring washer(H) and nuts(J).

IMPORTANT:
AFTER COMPLETING ALL THE STEPS, GO OVER THE ENTIRE UNIT AND TIGHTEN ALL BOLTS BEFORE ALLOWING CHILDREN TO USE.

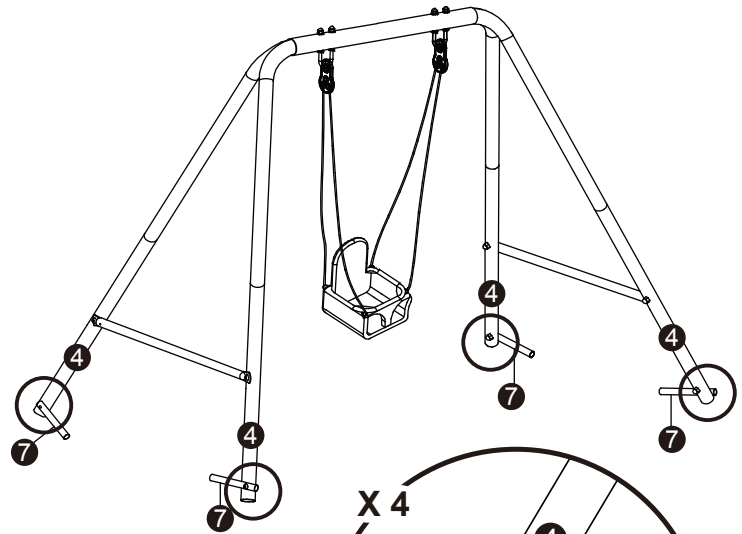

C	F	H	J
x 4pcs	x 8pcs	x 4pcs	x 4pcs

Step 6

Ensure the anchor is pointing inwards at a 45 degree angle to the ground.

Use a hammer(not included) to hit the anchor until fully in the ground.

Repeat this step for the remaining anchors.

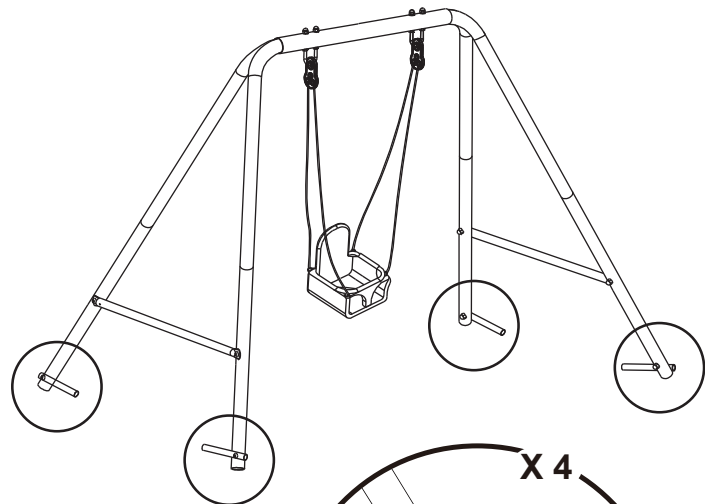

Assembly Instructions

To secure the child in the nursery swing

Note : Lock the seat belt tightly over the child.

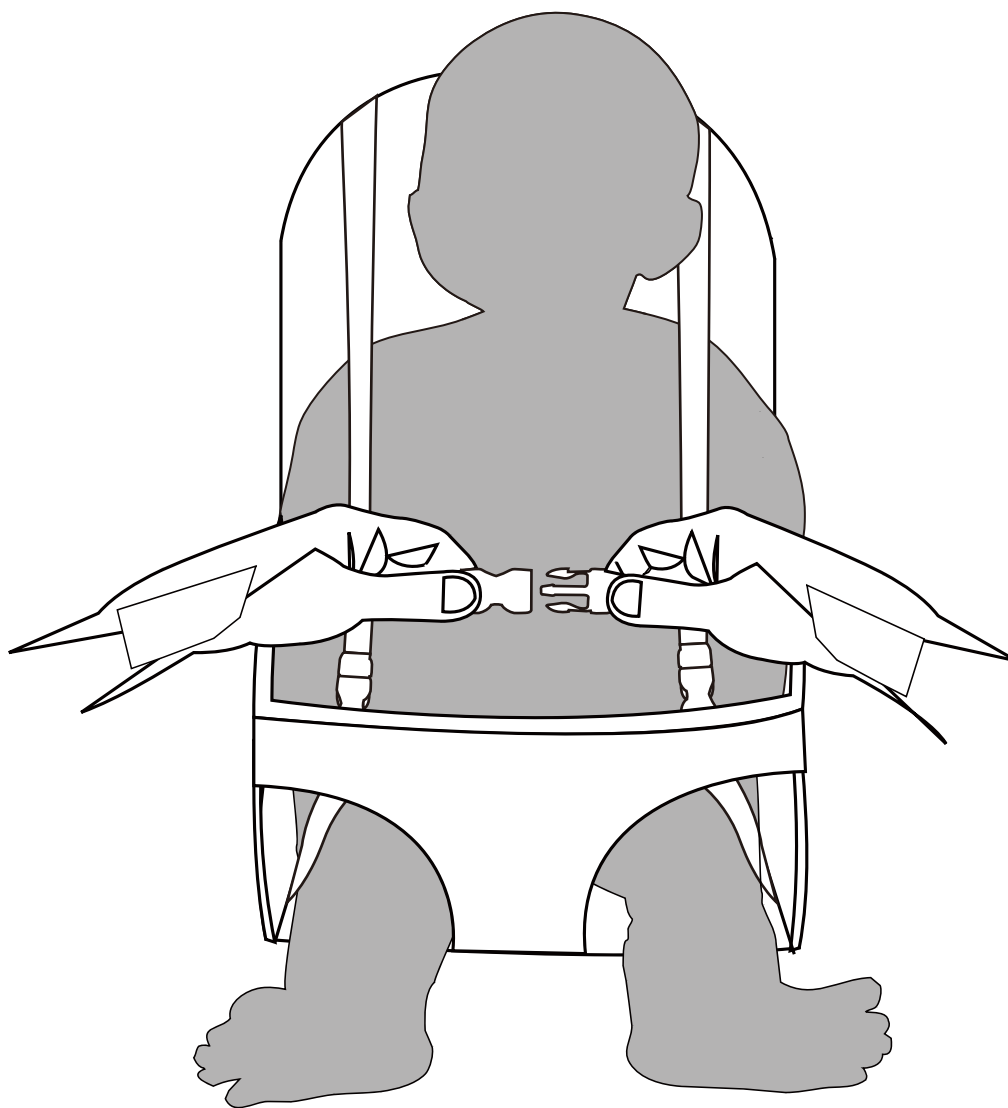

WARNING!

ADULT SUPERVISION REQUIRED AT ALL TIMES.

Care and Maintenance

General

This Nursery Swing was designed and manufactured with quality materials and craftsmanship.

If correct care and maintenance is provided, it will provide users with years of exercise, fun and enjoyment.

Inspect regularly for:

- Check all nuts and bolts twice monthly during the usage season for tightness and tighten as required. It is particularly important that this procedure be followed at the beginning of each season.
- Never use pliers to tighten up screws –these can cause damage to both the paintwork and the special anti-corrosion plating.
- Tighten all nuts and bolts securely. Replace as needed. If not checked regularly, bolts can be loose or missed and components can become detached and cause injuries.
- Check the unit at the beginning of the usage season and monthly thereafter for evidence of deterioration.
- Immediately remove and replace any items that appear to be weak or broken. Contact Customer Support for replacement parts.
- Check all covers designed for bolts and sharp edges regularly to be certain they are present and in good condition. Replace as needed. It is particularly important that all covers are checked prior to the first use each season.
- Inspect handle bar, hardware, and etc., for proper closure and for signs of wear, deterioration, rust and/or damage. Replace as needed.
- Lubricate all metallic moving parts monthly during the usage season. Applying a light coat of automobile wax to all metal tubing surfaces will help protect your unit and add to its longevity. Sand any rusted areas of the metal tubing and repaint using a non-lead based paint.
- Remove plastic seats and store indoors, or do not use when the temperature drops below 32°F/0°C.
- Check unit for scuffs, burrs, sharp edges and any other defects that may occur from assembly, abuse, shipping or everyday use. Burrs and sharp edges may be filed down until smooth and covered with duct tape if necessary.
- To help maintain the products appearance, occasionally clean the seats and metal framework with a damp cloth lightly – but DO NOT use abrasive chemical cleaners.
- When the time comes to disassemble and dispose of this product, please completely disassemble the unit and discard of it in a safe place and manner so as not to present any hazard to any individual. It is important to check and maintain the main parts at regular intervals. If these checks are not carried out, the toy could overturn or otherwise become a hazard. Whenever practical, the instructions shall also be affixed to the toy.
- **IMPORTANT!KEEP FOR FUTURE REFERENCE.**

WARNING!

This swing is for Domestic Family use only and is intended for outdoor use. This swing is designed for children between the ages of 12 – 36 months. Max weight of user shall not exceed 25kg. Do not allow children to stand on the swing seat. Do not allow children to get off of the swing whilst it is still moving. Do not twist swing ropes or wrap them over the top cross beam. Packaging materials are not toys. Please remove all packaging and packing tags/wires before giving this toy to your child.



If you need help or have damaged or missing parts, call the Customer Helpline: (+44) 0330 0904 420
Produced in China for Argos Limited, London, EC1M 6HA, UK. Argos (N.I.) Ltd,
Forestside Shopping Centre, Upper Galwally, Belfast, BT8 6FX, UK.
argos.co.uk/help/contact-us
Visit www.argos.co.uk/chadvalley