

2-IN-1 SWING

USER AND ASSEMBLY MANUAL

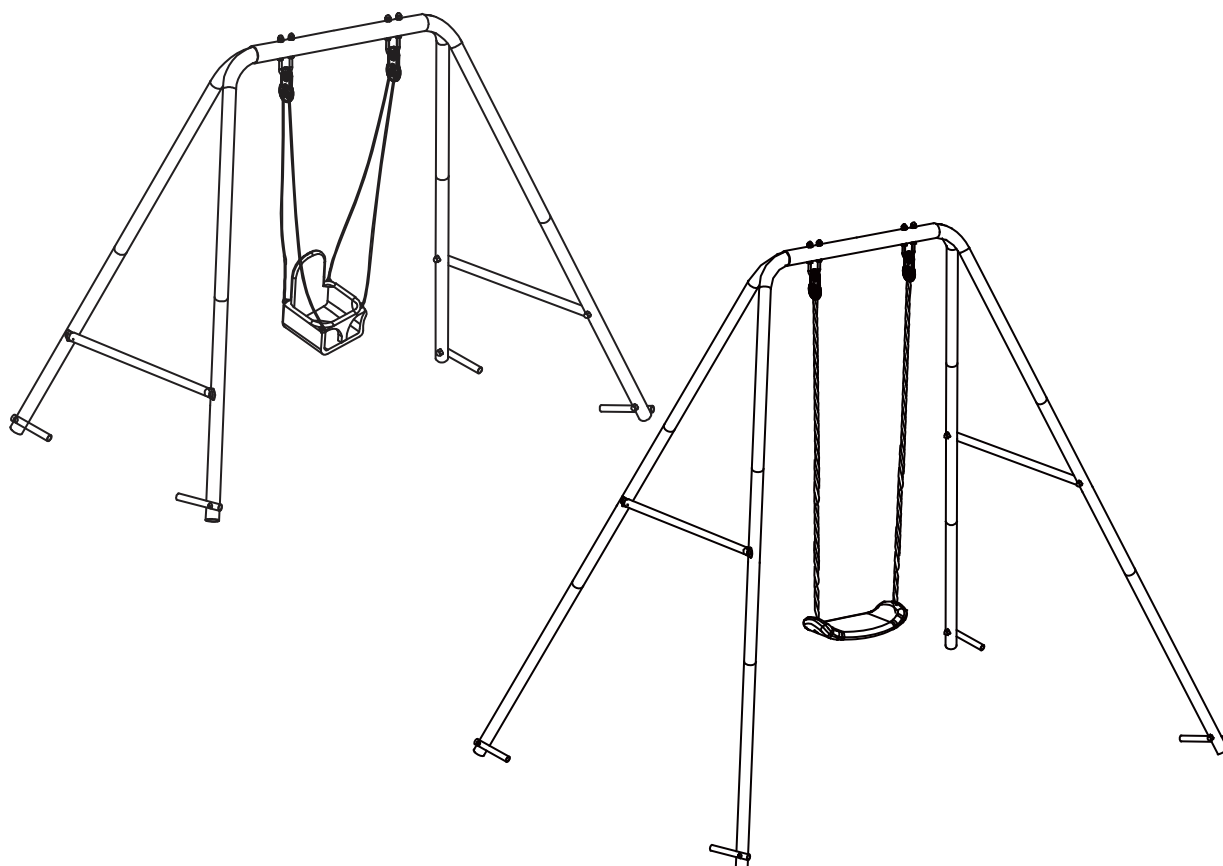

Tips : It will take 2 people around 45 mins to assemble this product.



WARNINGS!



- Misuse and abuse of this product can result in injury.
- Read instructions before assembly or using this product. Retain Instructions.
- Always inspect product before use, checking for worn, defective or missing parts.
- The single swing is suitable for age 3-8 years with maximum user weight of 45kg.
- The nursery swing is suitable for ages 12-36 months with maximum user weight of 25kg.
- Do not stand on the swing.
- Adult supervision at all times.
- Only for outdoor and domestic use.
- Before you start assembly please check all parts are included, if any parts are missing or you need advice, please contact Customer Services: by email support@sportspowerfit4kids.com, by phone (+44) 0330 0904 420 or visit www.sportspowerfit4kids.com

SW-003

SAFETY INFORMATION

IMPORTANT - Please read these instructions fully before assembly or use.

Top Tips before you start















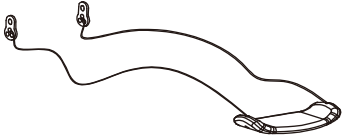
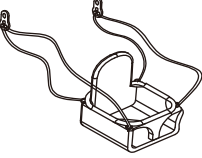

WARNING. FOR DOMESTIC USE ONLY.

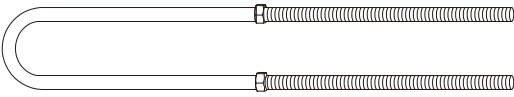
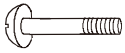
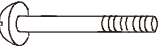
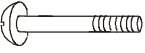
- Please check to ensure all parts are present before you start the assembly of this unit. If any missing parts, please properly store the product away and contact our customer service representatives for assistance.
- Assembly by adult(s) required. Do not allow children under 3 nearby during assembly to avoid choking hazard from small parts.
- Constant adult supervision is required during use of this product.
- At the start of assembly, do not tighten bolts/nuts completely so as to allow some possible adjustment. After all major components are assembled, go back over all bolts and nuts and properly tighten all of them before using this product.
- Instruct children to avoid swinging the empty swing and not twist the swing chain or loop them over the top support bar since this may reduce the strength of the chain or rope.
- Do not allow children to climb on the structure of the swing (eg legs, top bar, cross bars and other parts).
- Instruct child to sit in the centre of the swing with their full weight in the center of the seat.
- Ensure that children wear suitable clothing whilst using this equipment. Never allow children to wear loose clothing, neck ties, scarves, drawstrings or loose jewellery.
- Please remove all packaging and packing tags/ wires before allowing your child to use. Please take note: As an extra precaution, check this product regularly for signs of wear or damage.
- Protective surfacing: One of the most important things you can do to reduce the likelihood of serious head injuries is to install **Shock-Absorbing Protective Surfacing (over the ground)** under and around your play equipment. We recommend you use loose-fill materials such as wood mulch/chips, engineered wood fibre, shredded/recycled rubber mulch or sand gravel. The surfacing will also compact, displace, and settle, and should be periodically refilled. Carpeting and thin mats are generally not adequate protective surfacing, check and maintain the depth of the loose-fill surfacing material. Maintain the right amount of loose-fill material. Do not install loose fill surfacing over hard surfaces such as concrete or asphalt.

Read and follow all instructions

- The single swing is suitable for age 3-8 with maximum user weight of 45kg.
- The nursery swing is suitable for ages 12-36 months with maximum user weight of 25kg.
- The equipment is designed for outdoor domestic use only and is not permitted for hiring or commercial use.
- Adult supervision is required at all times while the swing is in use. Never leave children unattended during play.
- Do not use the equipment in any manner other than intended.
- Please retain these instructions for future reference
- The product should not be installed over concrete, asphalt or any other hard surfaces. The equipment should be placed on a level surfaces at least 2 m from any structure or obstruction such as a fence, garage, house, overhanging branches, laundry lines or electrical wires.
- Do not use the equipment until it has been fully assembled and anchored, and all the components are properly secured. All the chains/ropes/cables cannot be looped back on themselves.
- Never allow children to disembark from the play equipment whilst it is still in motion.
- Ensure that children are not facing the sun whilst using the equipment.
- Do not attach items to the equipment that are not specially designed for use with this product, including but not limited to cables, shipping ropes and chains as they may cause strangulation hazards.
- Never allow children to walk too close to, in front of, behind or in between the equipment whilst in use, always keep children a safe distance from the product whilst in use.
- Do not allow reckless playing, such as jumping off, standing on seats or climbing ropes.
- Do not allow children to use when the swing seat is wet.

CONTENTS

1 x1 Beam 	2 x2 Leg Tube 	3 x2 Leg Tube 	4 x4 Leg Tube 	
5 x2 Rail 	6 x4 Leg Tube 	7 x4 Anchor 	8 x1 Single Swing Seat 	
9 x1 Nursery Swing Seat 	10 x4 Plastic Cap 	A x2 (M8) 	B x8 (M6x38mm) 	
C x4 (M6x53mm) 	D x4 (M6x42mm) 	E x8 (Φ8.5 x Φ19mm) 	F x32 (Φ6.5 x Φ14mm) 	H x4 (Φ8.5 x Φ13.5mm) 
I x16 (Φ6.5 x Φ10mm) 	J x4 (M8) 	K x16 (M6) 	L x1 (10&13mm) 	M x1 (4mm) 

For faulty or missing parts please contact customer services: call (+44) 0330 0904 420, Email support@sportspowerfit4kids.com or visit www.sportspowerfit4kids.com

ASSEMBLY

step 1

- Insert Legs (2) and (3) into Beam (1) as shown in FIGURE1.
- Please note the order of Legs (2) and (3) need to be inverse on the two sides of the beam.

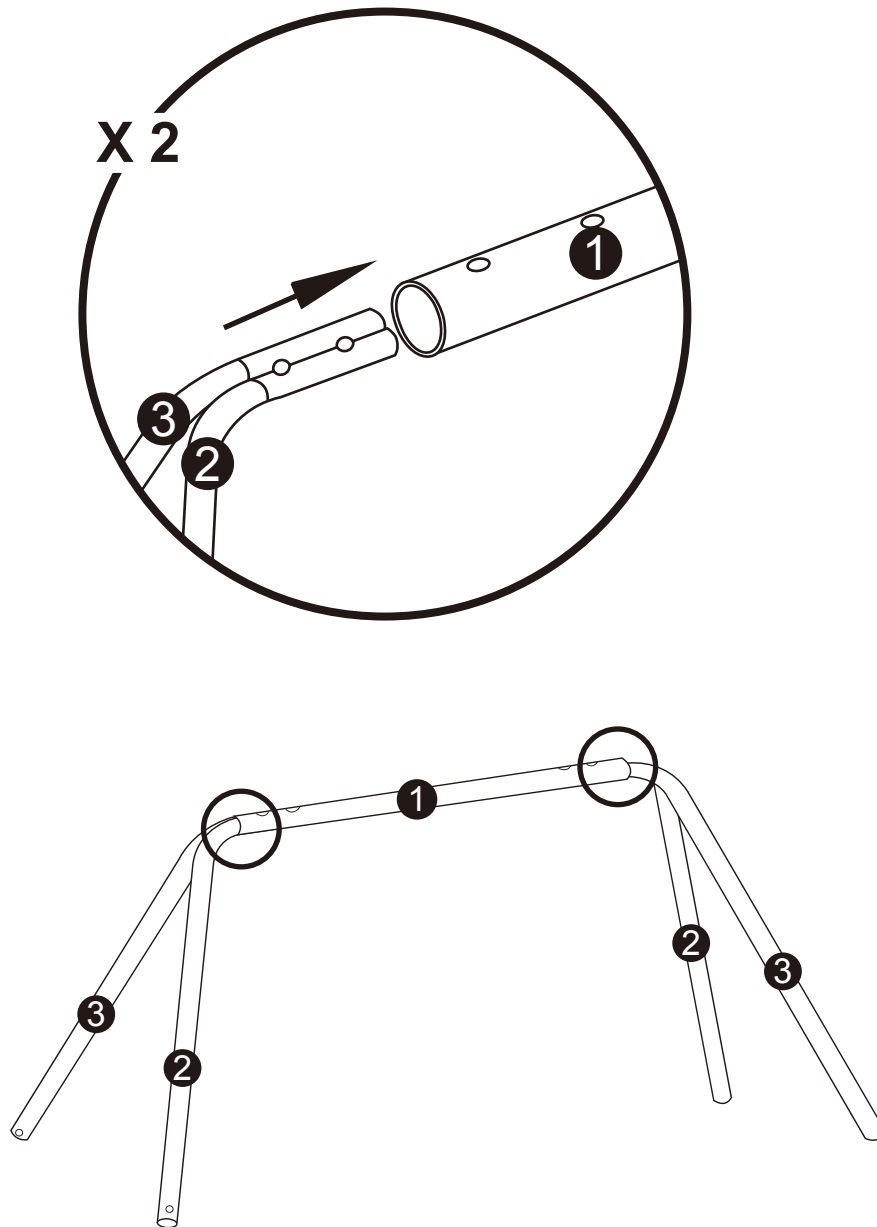

Figure 1

ASSEMBLY

step 2

- Insert Legs (4) into (2) and (3).
- Secure with B,F,I and K in the sequence shown in FIGURE 2.

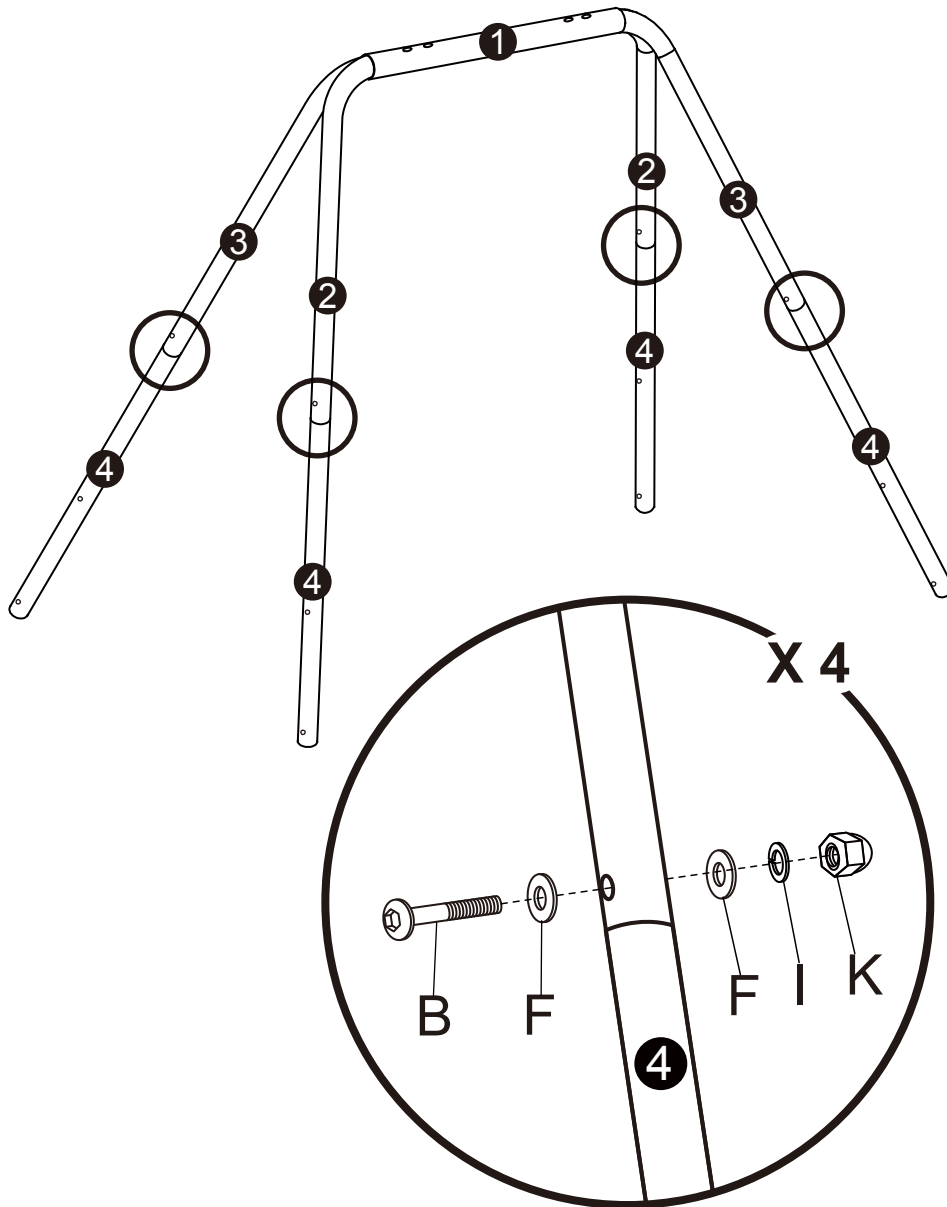
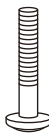





FIGURE 2

			
x 4	x 8	x 4	x 4
B	F	I	K

ASSEMBLY

step 3

- Attach Plastic Cap (10) to each side of Rail (5) Secure Rail to Legs (4) on both sides of the swing using D,F,I and K in the sequence shown in FIGURE 3.

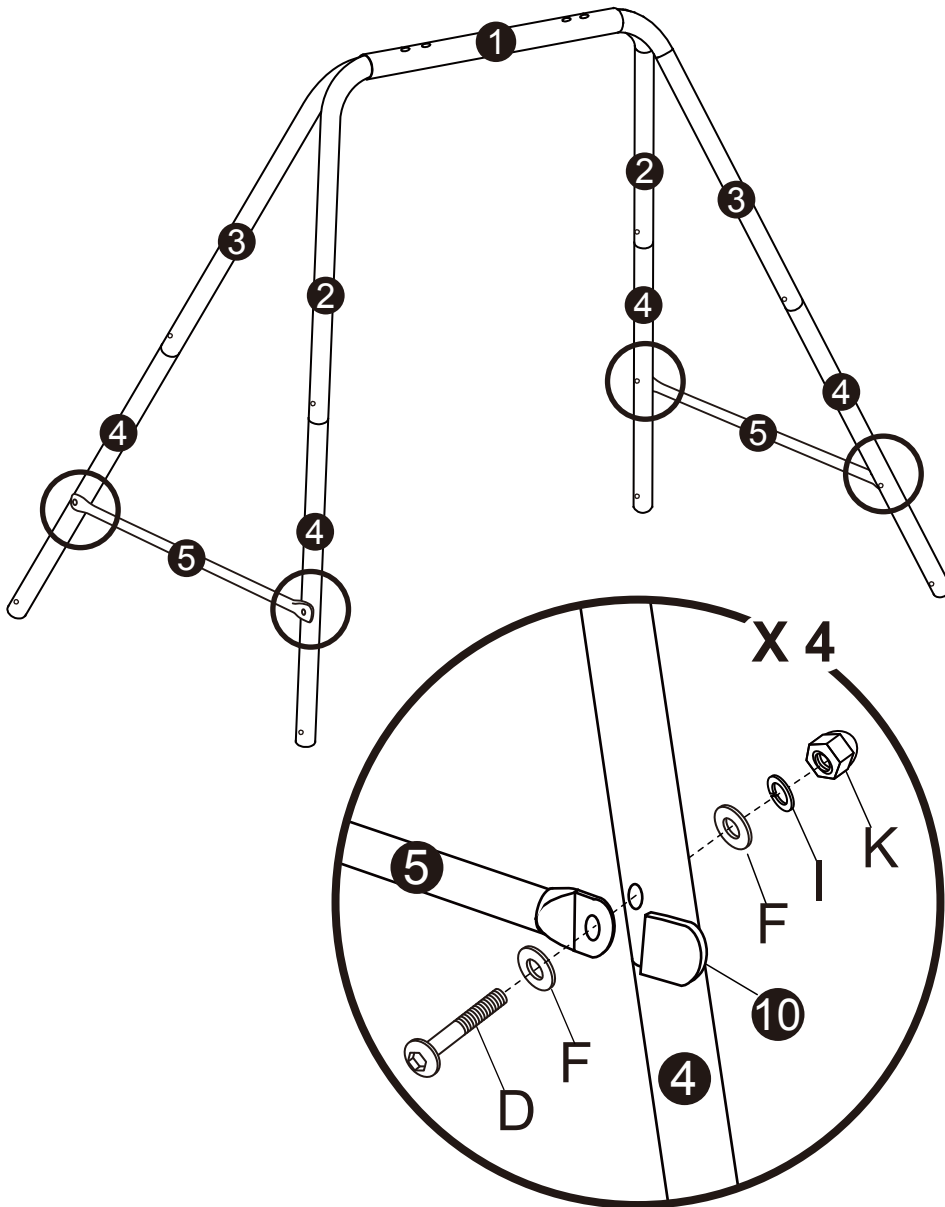
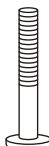





FIGURE 3

			
x 4	x 8	x 4	x 4
D	F	I	K

ASSEMBLY

step 4

For Nursery Swing Seat (See steps 6 and 7 for Single Swing Seat)

- Secure the swing to Beam (1) using A, E, H, and J in the sequence shown in FIGURE 4.

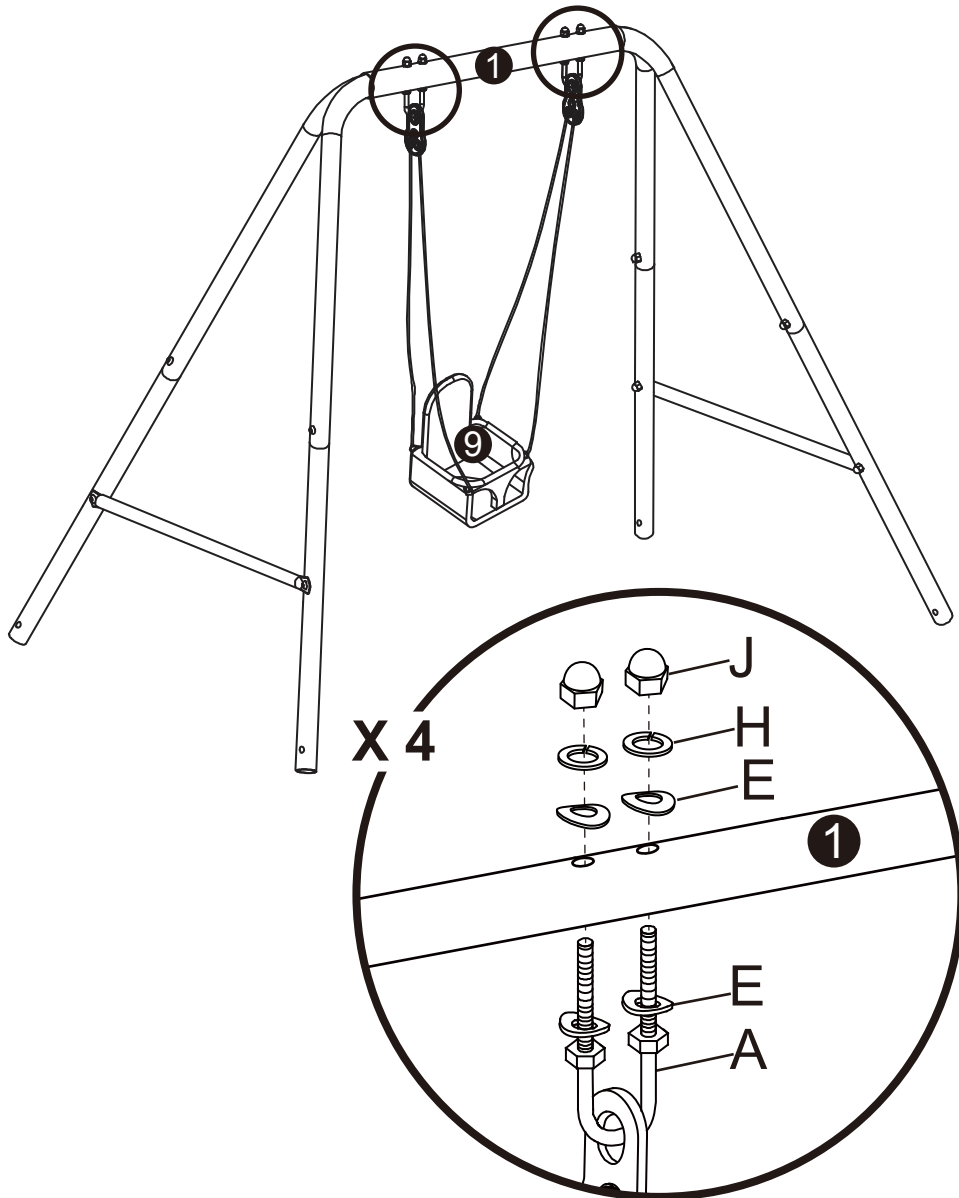

FIGURE 4

x 2	x 8	x 4	x 4
A	E	H	J

ASSEMBLY

step 5 For Nursery Swing Seat (See steps 6 and 7 for Single Swing Seat)

Note: Lock the seat belt tightly over the child shown in FIGURE 5.

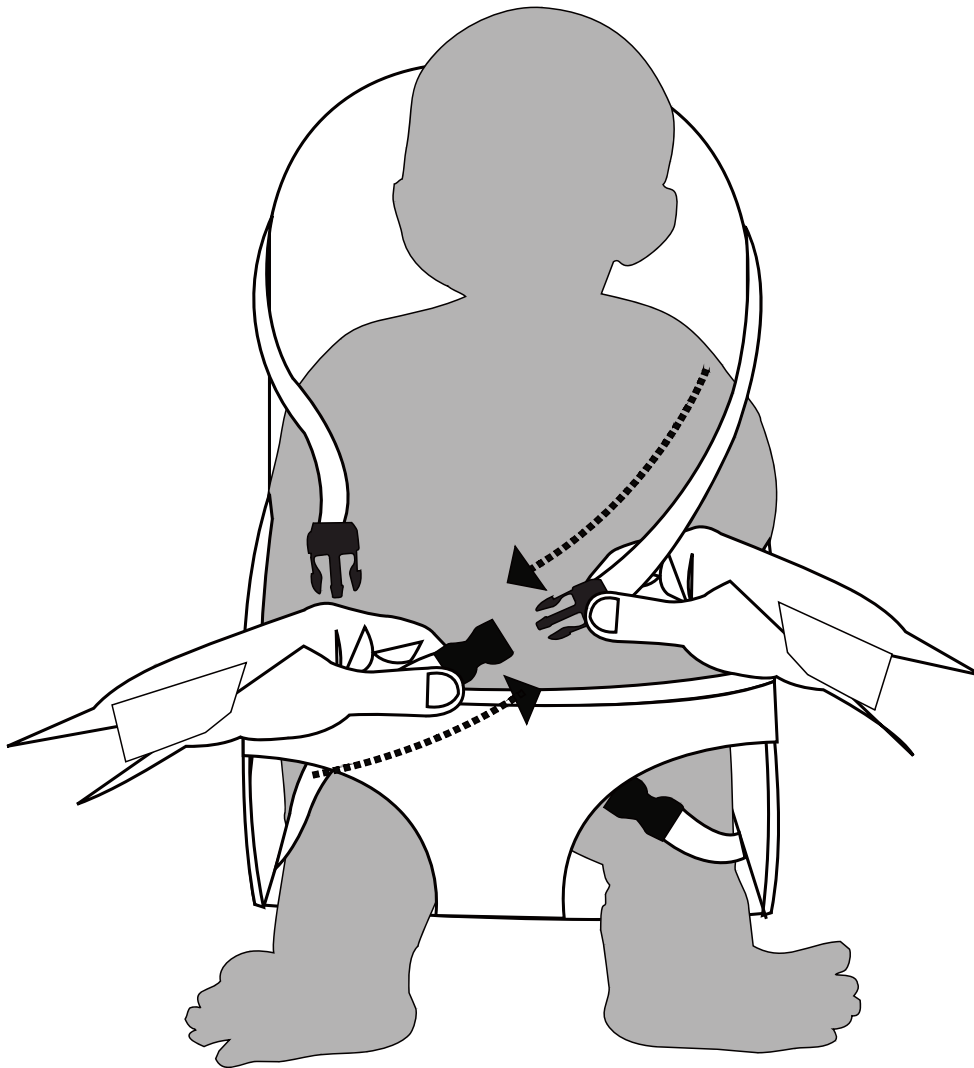

FIGURE 5



WARNING!

CONSTANT ADULT SUPERVISION REQUIRED AT ALL TIMES DURING USE.

ASSEMBLY

step 6 For Single Swing Seat

- Attach Legs (6) to (4) using B,F,I and K in the sequence shown in FIGURE 6.

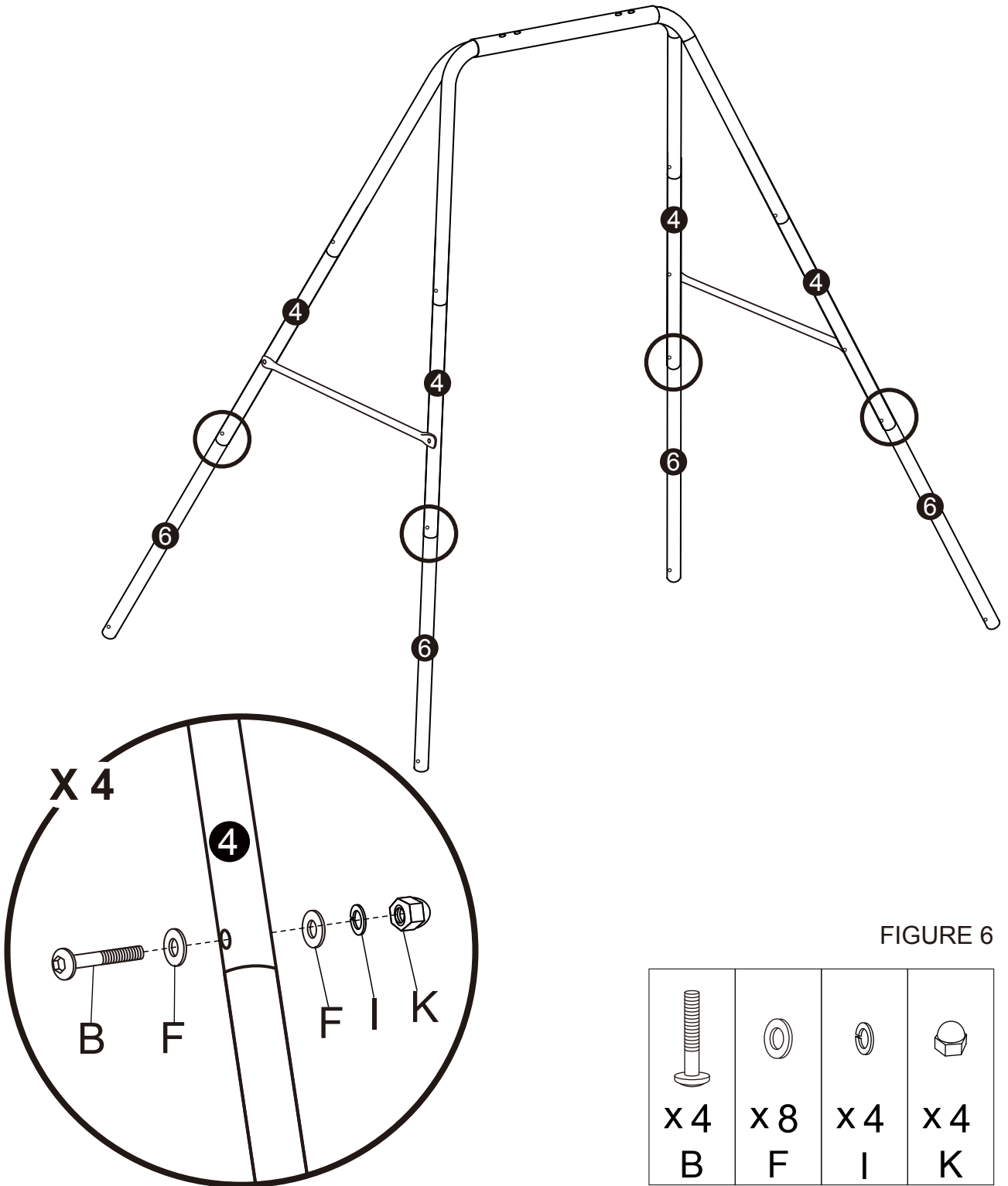
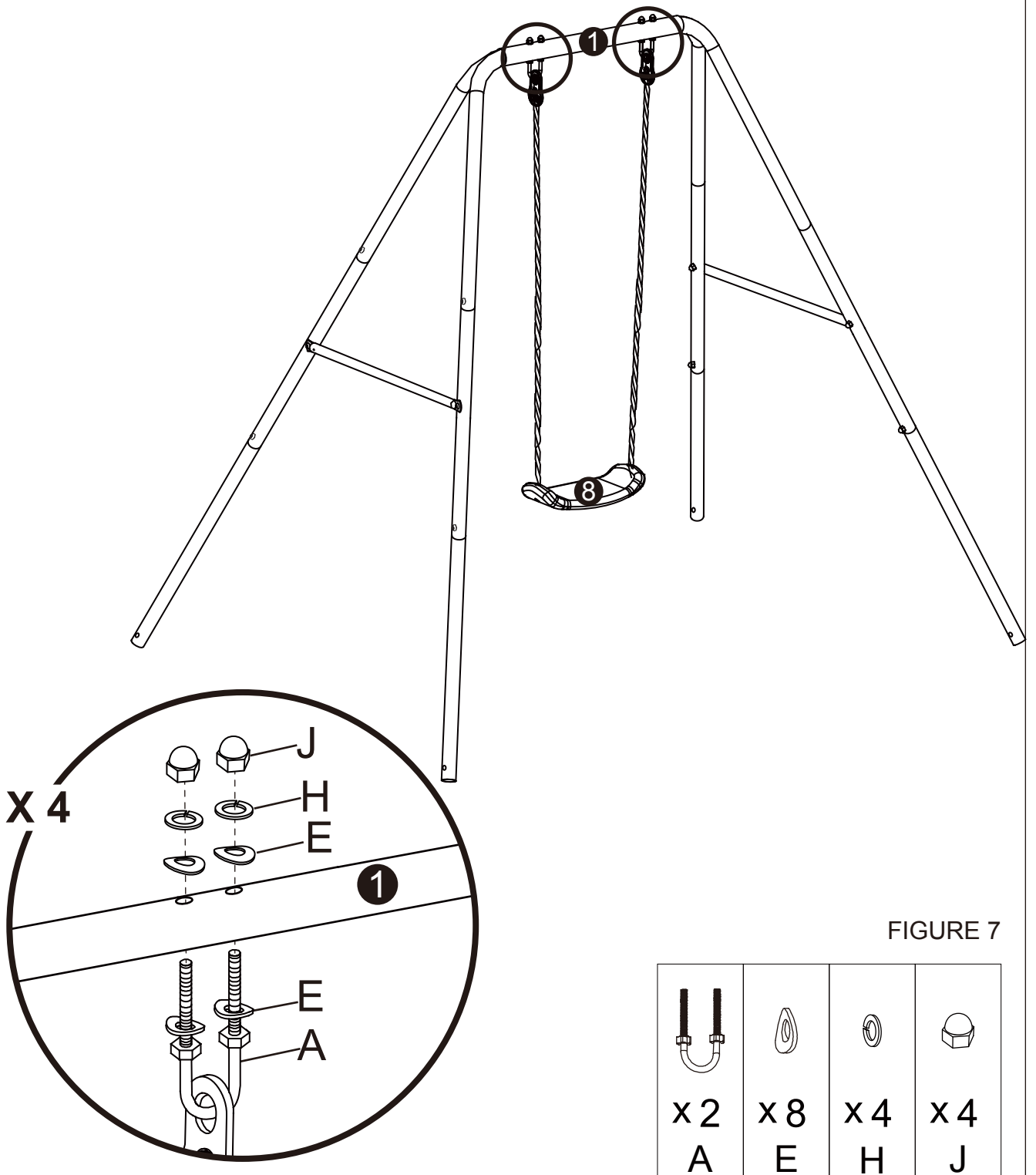

FIGURE 6

ASSEMBLY

step 7 For Single Swing Seat

- Secure the swing to Beam (1) using A, E, H and J in the sequence shown in FIGURE 7.



ASSEMBLY

step 8 For Nursery and Single Swing Seat

- Attach Anchor (7) to the base of all four Legs (6) using C,F,I and K in the sequence shown in FIGURE 7.

IMPORTANT: AFTER COMPLETING ALL THE STEPS, GO OVER THE ENTIRE UNIT AND TIGHTEN ALL BOLTS BEFORE ALLOWING CHILDREN TO USE.

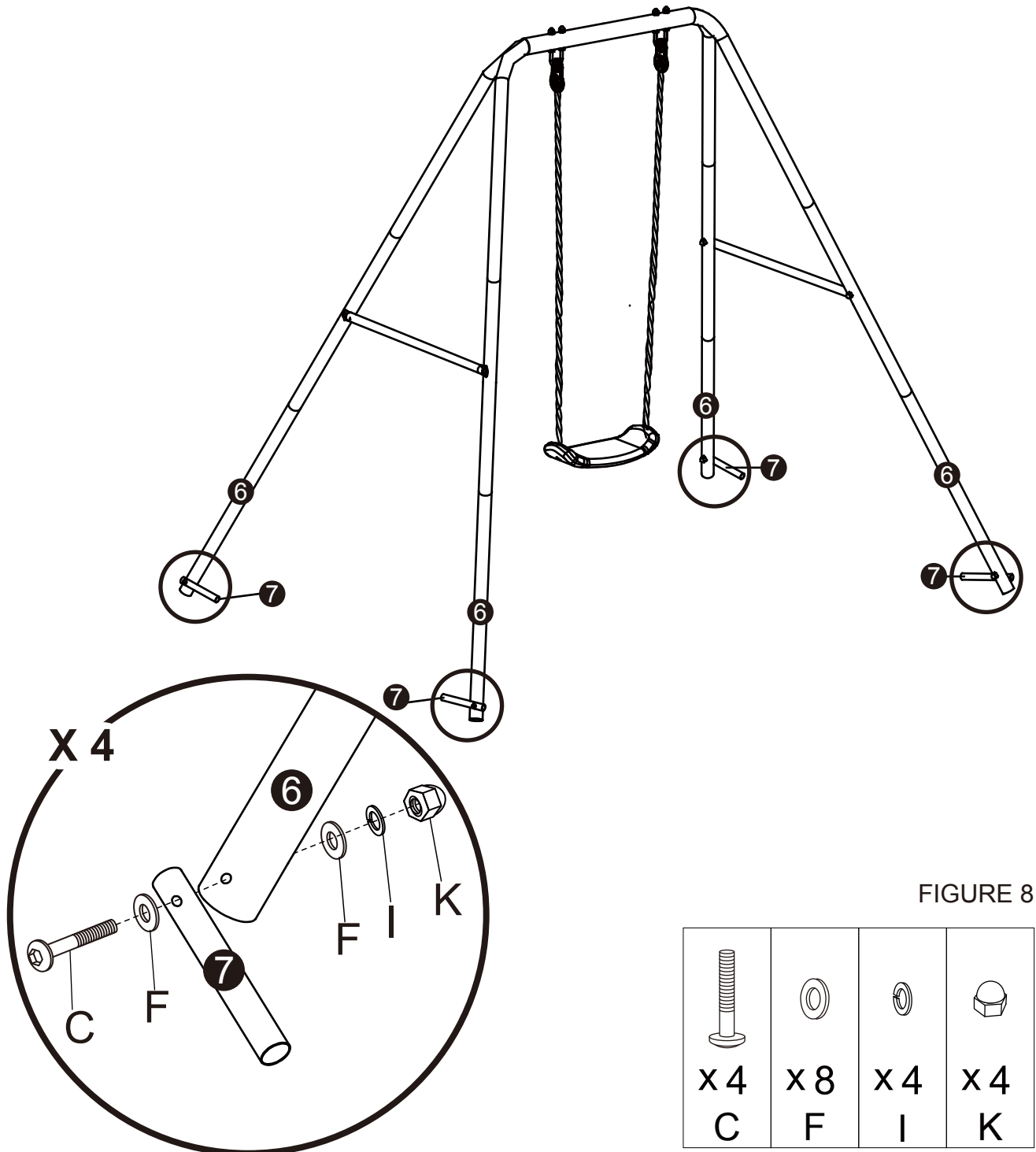

FIGURE 8

ASSEMBLY

step 9 For Nursery and Single Swing Seat

- Position the anchors at 45 degree angle and secure them fully into the ground until the leg of the swing is standing flat and stable on the ground.

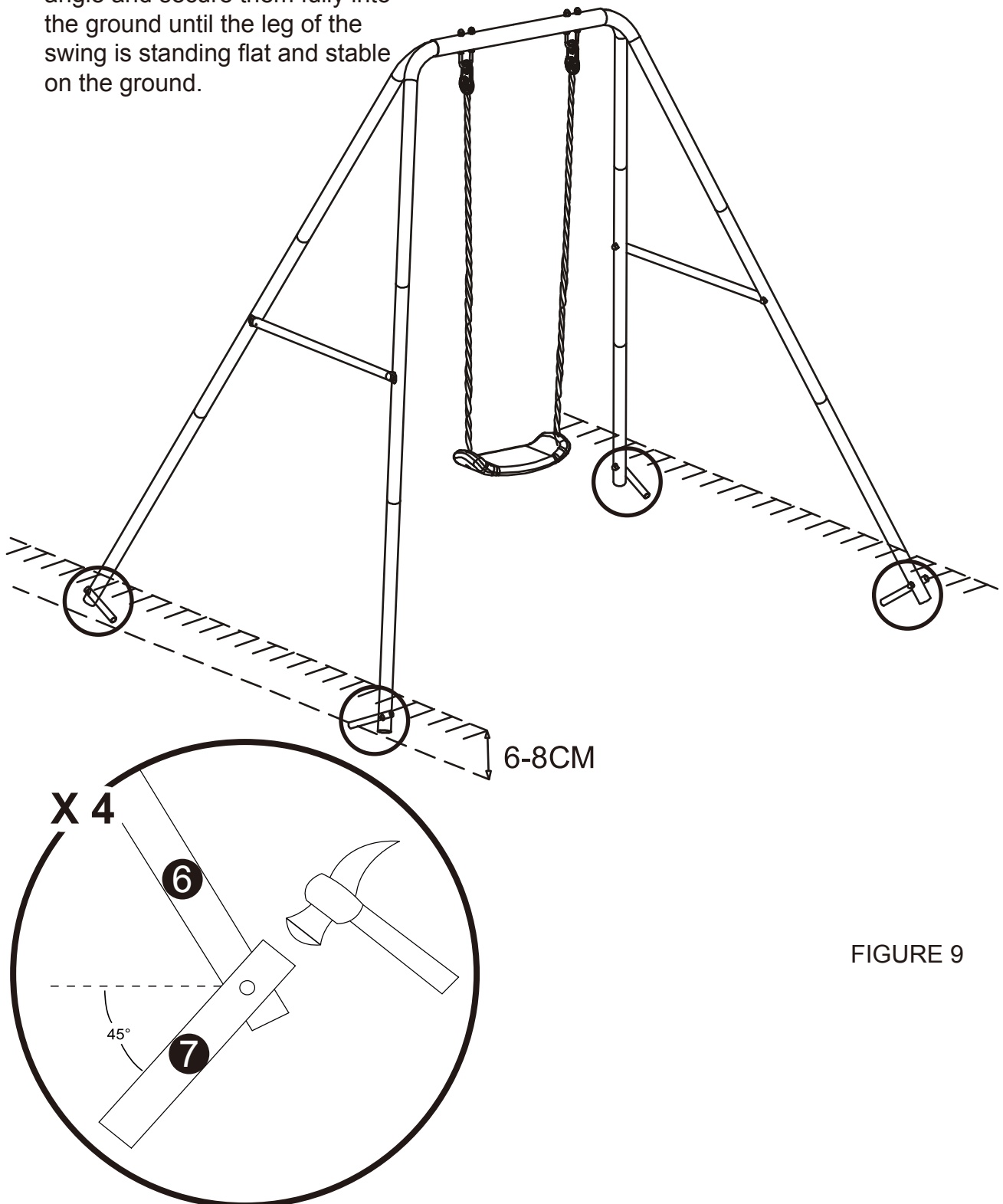

FIGURE 9

ASSEMBLY

SEAT ADJUSTABLE GUIDE

THE LENGTH OF THE ROPE IS ADJUSTABLE FOR THE HEIGHT OF THE CHILD THROUGH THE SEAT CONNECTOR.

TO ADJUST, LOOSEN THE KNOT ON THE SEAT CONNECTOR, PULL ROPE THROUGH THE HOLES AND TIGHTEN AGAIN.

MAKE SURE THAT THE KNOTS ARE TIGHT AND THAT BOTH ROPES ARE ADJUSTED SO THAT THE SEAT IS HORIZONTAL.

IMPORTANT: MINIMUM CLEARANCE BETWEEN THE FOOTREST/SEAT AND THE GROUND SHOULD BE 35 CM.

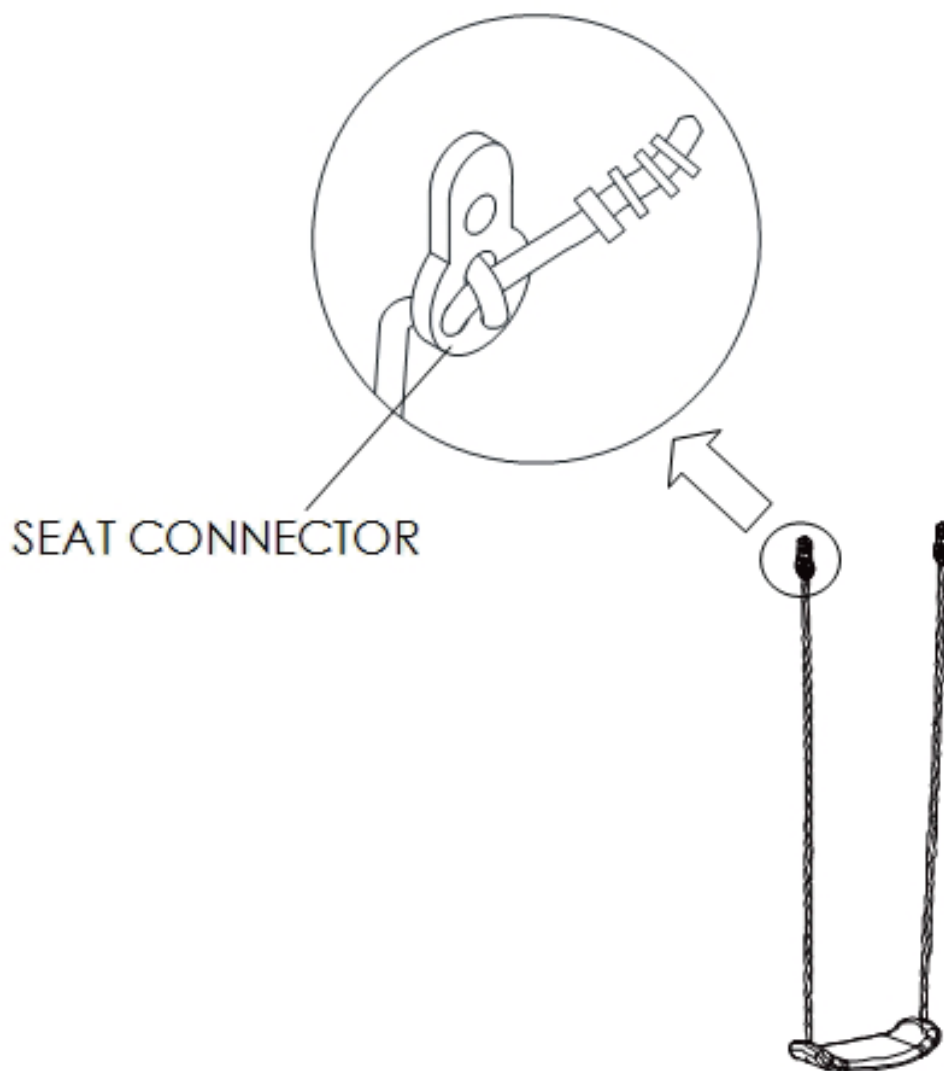

CARE AND MAINTENANCE

General

This 2-in-1 Swing was designed manufactured with quality materials and craftsmanship. If correct care and maintenance is provided, it will provide users with years of exercise, fun and enjoyment.

Inspect regularly for:

- CHECK ALL NUTS AND BOLTS TWICE MONTHLY DURING THE USAGE SEASON AND TIGHTEN AS REQUIRED. IT IS PARTICULARLY IMPORTANT THAT THIS PROCEDURE BE FOLLOWED AT THE BEGINNING OF EACH SEASON.
- Never use pliers to tighten up screws –these can cause damage to both the paintwork and the special anti-corrosion plating.
- Immediately remove and replace any items that appear to be weak or broken. Contact Customer Support for replacement parts.
- Lubricate all metallic moving parts monthly during the usage season. Applying a light coat of automobile wax to all metal tubing surfaces will help protect your unit and add to its longevity. Sand any rusted areas of the metal tubing and repaint using a non-lead based paint.
- Remove plastic seats and store indoors, or do not use when the temperature drops below 32°F/0°C.
- Check unit for scuffs, burrs, sharp edges and any other defects that may occur from assembly, abuse, shipping or everyday use. Burrs and sharp edges may be filed down until smooth and covered with duct tape if necessary.
- To help maintain the products appearance, occasionally clean the seats and metal framework with a damp cloth lightly – but DO NOT use abrasive chemical cleaners.
- When the time comes to disassemble and dispose of this product, please completely disassemble the unit and discard of it in a safe place and manner so as not to present any hazard to any individual. It is important to check and maintain the main parts at regular intervals.If these checks are not carried out,the toy could overturn or otherwise become a hazard.Whenever practical,the instructions shall also be affixed to the toy.

IMPORTANT!KEEP FOR FUTURE REFERENCE.

WARNING!

- Nursery Swing is suitable for children between ages 12-36 months with maximum weight of 25kg.
- Single Swing is suitable for children between 3-8 years old with maximum weight of 45kg.
- Do not allow more than one user at the same time.
- Constant adult supervision required at all times during use. Do not leave children unattended.
- For domestic use only. Not for rental or commercial use.
- Adult assembly required. Make sure to properly dispose of all packaging material and do not allow children nearby during assembly due to small parts: choking hazard!

PRODUCT WARRANTY

All warranty coverage extends only to the original purchaser of the product and is not assignable or transferable. The original store or online purchase receipt must be kept as proof of purchase in order for the warranty to be valid. These documents must be presented in the event of making a claim under warranty.

During the warranty period, Sportspower will provide repair or replacement of defective equipment or parts thereof covered by the warranty. Any handling, transportation, delivery and other incidental charges in respect of the servicing of the equipment shall be borne by the Purchaser. If the product includes a number of accessories, only the defective part or accessory will be replaced.

The warranty will become void if any defects or damages are associated with the use of unauthorized replacement parts. All replacement parts must be obtained from Sportspower authorized agents.

All decisions made by Sportspower in respect of the servicing of the equipment (including repairs, replacements or issues relating to defects of workmanship or materials) shall be conclusive and the Purchaser agrees to be bound by such decisions. Any defective equipment or part thereof replaced shall become the property of Sportspower.

In the event of a product or accessory being replaced during the guarantee, the guarantee on the replacement will expire at the original date, i.e. 90 days from the original purchase date.

This warranty excludes defects caused by the product not being used in accordance with instructions, accidental damage, misuse or being tampered with by unauthorized persons.

The Sportspower Limited Warranty does not cover:

(a) Products used for commercial or rental purposes.

(b) Loss or damage to product due to: (i) abuse, repairs and/or tampering by any person other than the authorized personnel of Sportspower; (ii) negligence and/or misuse (including foreign object, accident, improper storage, exposure to sun/moisture, excessive temperature, sand, dust, dirt, other pollution or other environmental conditions and failure to follow precautions or proper operating instructions stated in the User's Manual such as improper installations); (iii) fire, flood, lightning strike, wind storm or other acts of God; (iv) freight or improper transport damages, and (v) improper usage (including use by under-age, over-weight or excessive number of users permitted as stated in the User's Manual).

(c) Defects, damages or accidents due to the malfunction, connection to or use of non-Sportspower or unauthorized parts. In such event, Sportspower reserves the right to cancel the Limited Warranty coverage immediately.

To the extent allowed by the applicable local law, the remedies in the Limited Warranty are the Purchaser's sole and exclusive remedies.

SPORTSPOWER IS NOT RESPONSIBLE OR LIABLE FOR INDIRECT, SPECIAL OR CONSEQUENTIAL DAMAGES ARISING OUT OF OR IN CONNECTION WITH THE USE OR PERFORMANCE OF THE PRODUCT OR OTHER DAMAGES WITH RESPECT TO ANY ECONOMIC LOSS, LOSS OF PROPERTY, LOSS OF REVENUE OR PROFITS, LOSS OF ENJOYMENT OR USE, COST OF REMOVAL, INSTALLATION OR OTHER CONSEQUENTIAL DAMAGES. SOME STATES DO NOT ALLOW THE EXCLUSION OR LIMITATION OF INCIDENTAL OR CONSEQUENTIAL DAMAGES. ACCORDINGLY, THE ABOVE LIMITATION MAY NOT APPLY TO YOU.

THE WARRANTY EXTENDED HEREUNDER IS IN LIEU OF ALL OTHER WARRANTIES AND ANY IMPLIED WARRANTY OF MERCHANTABILITY OR FITNESS FOR A PARTICULAR PURPOSE IS LIMITED IN ITS SCOPE AND DURATION TO THE TERMS SET FORTH HEREIN. SOME STATES DO NOT ALLOW LIMITATIONS ON HOW LONG AN IMPLIED WARRANTY LASTS. ACCORDINGLY, THE ABOVE LIMITATION MAY NOT APPLY TO YOU. THIS WARRANTY GIVES YOU SPECIFIC LEGAL RIGHTS. YOU MAY ALSO HAVE OTHER RIGHTS WHICH VARY FROM STATE TO STATE. THIS WARRANTY IS VALID ONLY IN THE UNITED STATES.

CUSTOMER SERVICE/ SPARE PARTS -(+44) 0330 0904 420
by email support@sportspowerfit4kids.com,
or visit www.sportspowerfit4kids.com

Geemac Sales & Marketing Ltd.
20 Queensbridge Bedford Road Northampton,
United Kingdom, NN4 7BF

Sportspower Ltd.
20/F, Parkview Centre, 7 Lau Li Street, Causeway Bay, Hong Kong
www.sportspowerltd.net