

CV MULTIPLAY - SWING, MONKEY BAR AND BUTTON SWING

Assembly & User Instructions - Please keep for future reference

853/8402

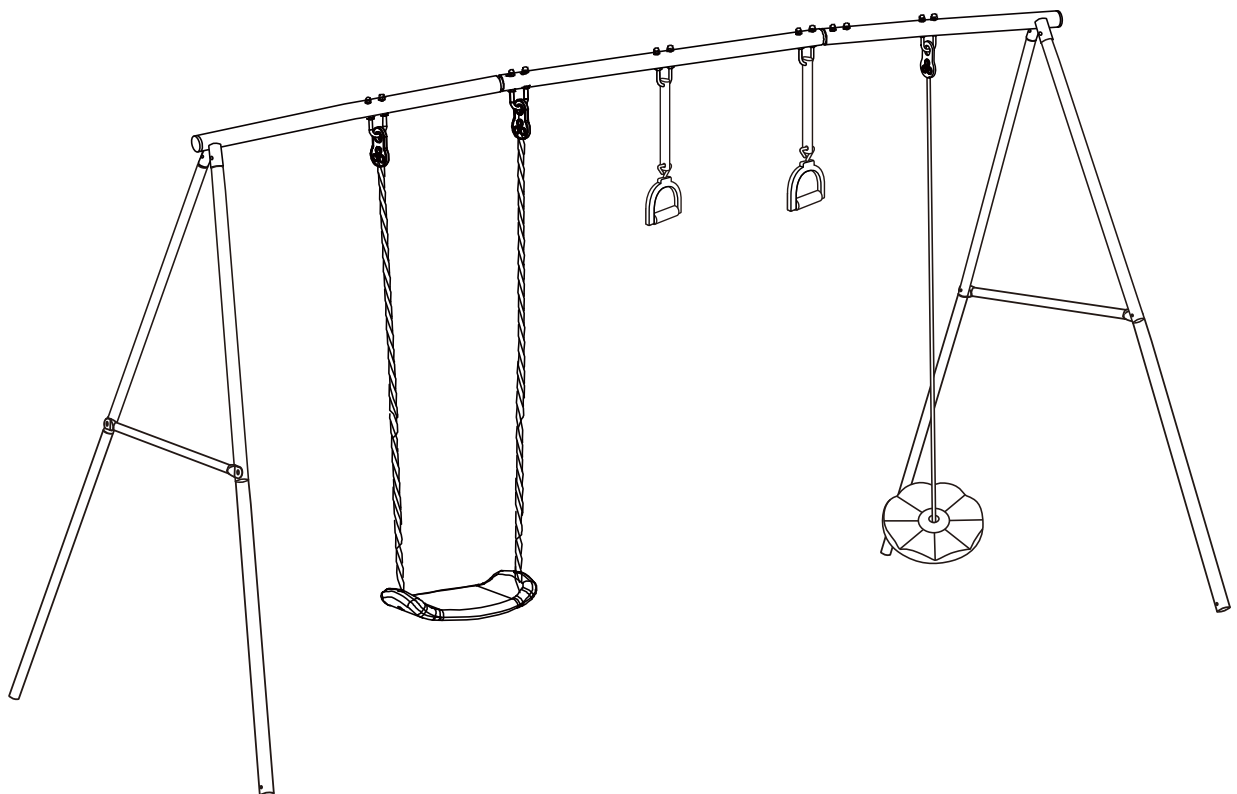

Important

Limit:
Age: 3 - 8 years
Maximum user: 3
Max user weight: 45kg per seat
Max combined weight: 135kg

Tips: It will take 2 adults around 30 minutes to assemble.

Important - Please read these instructions fully before assembly or use.

These instructions contain important information which will help you get the best from your product and ensure safe and correct assembly, use and maintenance.

If you need help or have damaged or missing parts, call the **Customer Helpline: (+44) 0330 0904 420**

Contents

Warning	2-3
Parts	4
Assembly Instructions	5-9
Care and Maintenance	10

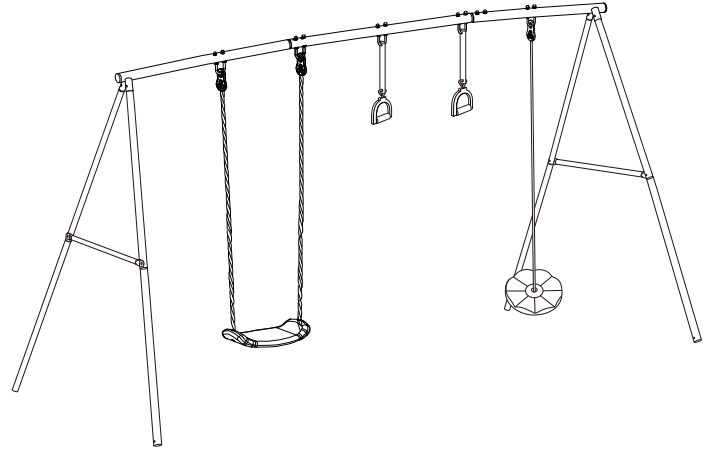



Warning

Important –Please read these instructions fully before assembly or use.



WARNING

Observing the following statements and warnings reduces the likelihood of serious injury.

- Warning! DO NOT allow children under the age of 36 months nearby during assembly as small part(s) and long cord(s) may be choking and entanglement strangulation hazards.
- This unit is designed to be used by up to 3 children between the age of 3 to 8, with a maximum weight of 45kg per component. Combined weight not to exceed 135kg.
- Provide on-site adult supervision for children of all ages at all times.
- It is recommended that the playground equipment be located on level ground and anchored. Be certain that all anchoring devices (including concrete) are placed below the level of the playing surface and covered with protective soft material to prevent tripping.
- Teach children to sit in the centre of the swing play items, with their full weight in the centre of the seats. DO NOT allow children to lean to the side when on play items or to collide with other playmates. DO NOT allow children to stand on the swing seat.
- Dress children appropriately while on and around this equipment. DO NOT allow children to wear ponchos, scarves, jewelry, loose shoes, jackets or clothing with loose strings and/or clothing that might be potentially hazardous whilst using this equipment.
- DO NOT let children use this equipment in any manner other than intended.
- Anchor all play equipment. DO NOT install over concrete, asphalt, gravel or any other hard surface which may cause injury should a fall occur. Swing set shall be placed over protective soft material such as sand bed, soft woodbark, grass lawn. The depth of sand and soft woodbark shall be a minimum of 183cm. The anchor shall be placed level with or under the ground in order to reduce tipping hazards.
- DO NOT let children use this equipment until it has been properly assembled and anchored. Place equipment on level ground not less than 2M from any structures or obstacles such as fences, overhanging branches, laundry or electrical lines, garages, sheds or houses.
- Instruct children not to swing empty play items. They may strike other children, or the play equipment may come back and strike you.
- Instruct children not to walk closely in front of, behind or in between moving play equipment. Instruct children to keep a safe distance away to avoid being struck by the items in use.
- Instruct children not to twist chains or ropes, or loop them over the support bar. This adds stress, reduces strength and may result in failure and cause injury.
- Instruct children not to get off play equipment whilst in motion. DO NOT allow children to jump from moving play equipment.

- DO NOT allow children to climb or play on the equipment whilst wet (slips or falls may occur).
- DO NOT allow children to climb on or swing from structural members (eg legs or top bar and chin bars). These are structural components ONLY and NOT play features.
- DO NOT allow children to swing play equipment more than 60 degrees.
- After completion of assembly, ensure all the nuts and bolts are tightened and in the correct position.
- Not suitable for hiring or commercial use.
- Never use the equipment in any manner other than intended.
- Please retain these instructions for future reference.
- Warning! only for domestic use.

Maintenance Instructions

- Check all nuts and bolts twice monthly during the season and tighten as required. We recommend you check the swing beam and hardware every two weeks. It is particularly important that this procedure be followed at the beginning of each season.
- Oil all metallic moving parts monthly during the usage period.
- Check all nuts and bolts twice monthly during the season to be certain they are in place. Replace when necessary. It is especially important to do this at the beginning of each new season.
- Check swing seats, ropes, cables and chains monthly during usage season for evidence of deterioration. Replacement should be made of any swing seat that has developed cracks in the plastic seat or has exposed metal in the edges of the swing seat. If there are already exposed metal inserts on the edge of the seat, immediately remove the seats and chains to prevent serious injury. Ropes, cables and chains should be removed and replaced if excessive wear is found. Contact OUR SERVICE CENTER for replacement parts.
- Maintaining the play set on a level location is very important. As your children play, your play set will slowly dig its way into soil, and it is very important that is settled evenly. Make sure the play set is level and true once each year or at the beginning of each play season.
- Product shall be accompanied by maintenance instructions drawing attention to the need of carrying out checks and maintenance of the main parts at regular intervals, if these checks are not carried out the product could overturn and otherwise become a hazard. Whenever practical, the instructions shall also be affixed to the product.



Safety Information

Important –Please read these instructions fully before assembly or use.

- Hardware: inspect for tightness.
- Swing hangers: check to insure correct installation. Make sure that the bend of the swing hanger is positioned tightly against the stop washer and swing beam. The axis of the swing hanger bushing must be perpendicular to the swing motion. If squeaking occurs the nylon bushings can be sprayed with WD-40 or other house hold lubricant.
- The instructions and owner's manual for your new play set should be read in its entirety before assembly, to minimize problems and safety issues. We recommend reading the owner manual thoroughly after you have identified all of the parts for your play set.
- Check all coverings for bolts and sharp edges and replace when required.
- DO NOT attach items to the playground equipment that are not specifically designed for use with this equipment, such as, but not limited to, jump ropes, clotheslines, pet leashes, cables and chains as they may cause strangulation hazards.
- At the end of each play season, remove all plastic parts and take indoors. DO NOT allow the use of plastic items when the temperature drops below 0 degree.
- Dispose of all packaging properly after the unit has been assembled.
- This equipment is for family domestic use and is intended for outdoor use only.
- Check all nuts and bolts for tightness and tighten when required.
- Check swing seats, chains, and other means of attachments for evidence of deterioration, replace when required in accordance with the manufacturer's instructions.
- Not suitable for children under 3 years because of small part(s)-choking hazard.
- This unit must be assembled by adults, ensure bolts and small components are kept out of reach of young children.
- Check all fixings regularly, tighten if necessary, and that the suspension system is secure.
- Check metal sections or components for signs of corrosion.
- Discontinue use if weakening or breakage found.
- Young children in play are unaware of potential dangers and hazards, therefore responsible adults supervision is essential.
- Failure to comply with these precautions may result in injury.
- Disassemble and store indoors during the winter.

Positioning Your Play Set

- Require at least 2 adults for assembly. Try to place in a flat area of your yard to minimize ground preparation. Place the equipment not less than 2M from any structure or obstruction such as a fence, garage, house, overhanging branches, laundry lines, or electrical wires.
- It is a good idea to place your play set in an area that is convenient for adults to watch children at play.
- The area that you choose should be policed for glass, rocks or anything jagged or sharp that could endanger your children's safety. The surface underneath your play system can cause or prevent injuries.
- Shredded bark mulch, wood chips, fine sand or fine gravel are considered to be acceptable shock-absorbing surfaces when installed and maintained at a sufficient depth under and around playground equipment. However each material is only effective when properly maintained. Material should be checked periodically and replenished to maintain correct depth as determined necessary for your equipment. Otherwise serious injuries may occur from a fall.
- Do not build your play set on top of surfacing material.
- Please install this equipment facing away from the sun to avoid causing dizziness whilst playing.

Parts

If you have damaged or missing parts,
call the **Customer Helpline: (+44) 0330 0904 420**

Please Check you have all the parts fittings listed below



1 Left Top Bar x 1pc



5 Lower Leg x 4pcs



9 Button swing x 1pc



2 Center Top Bar x 1pc



6 Cross Bar x 2pcs



10 Anchor x 4pcs

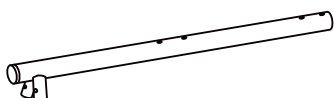

3 Right Top Bar x 1pc



7 Plastic cap x 4pcs



11 Swing Seat x 1pc



4 Upper Leg x 4pcs

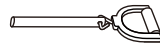

8 Monkey bar x 2pcs

Note: The quantities below are the correct amount to complete the assembly. In some cases more fittings may be supplied than are required.

<p>A</p> <p>×5 (M8x114mm)</p>	<p>B</p> <p>×4 (M8x50mm)</p>	<p>C</p> <p>×4 (M8x55mm)</p>	<p>D</p> <p>×36 (Ø19×Ø8.5mm)</p>
<p>E</p> <p>×4 (Ø19×Ø8.5mm)</p>	<p>F</p> <p>×20 (Ø8×Ø2mm)</p>	<p>G</p> <p>×20 (M8)</p>	<p>H</p> <p>×1 (10&13mm)</p>
<p>I</p> <p>×1 (6mm)</p>	<p>L</p> <p>×2 (M8×62mm)</p>		

Ruler - Use this ruler to help correctly identify the bolts/screws



Assembly Instructions

Step 1

Connect top bar (1), (2) and (3). Attach Upper Legs (4) to Left and Right Top Bar (1) and (3) as shown in Figure 1.

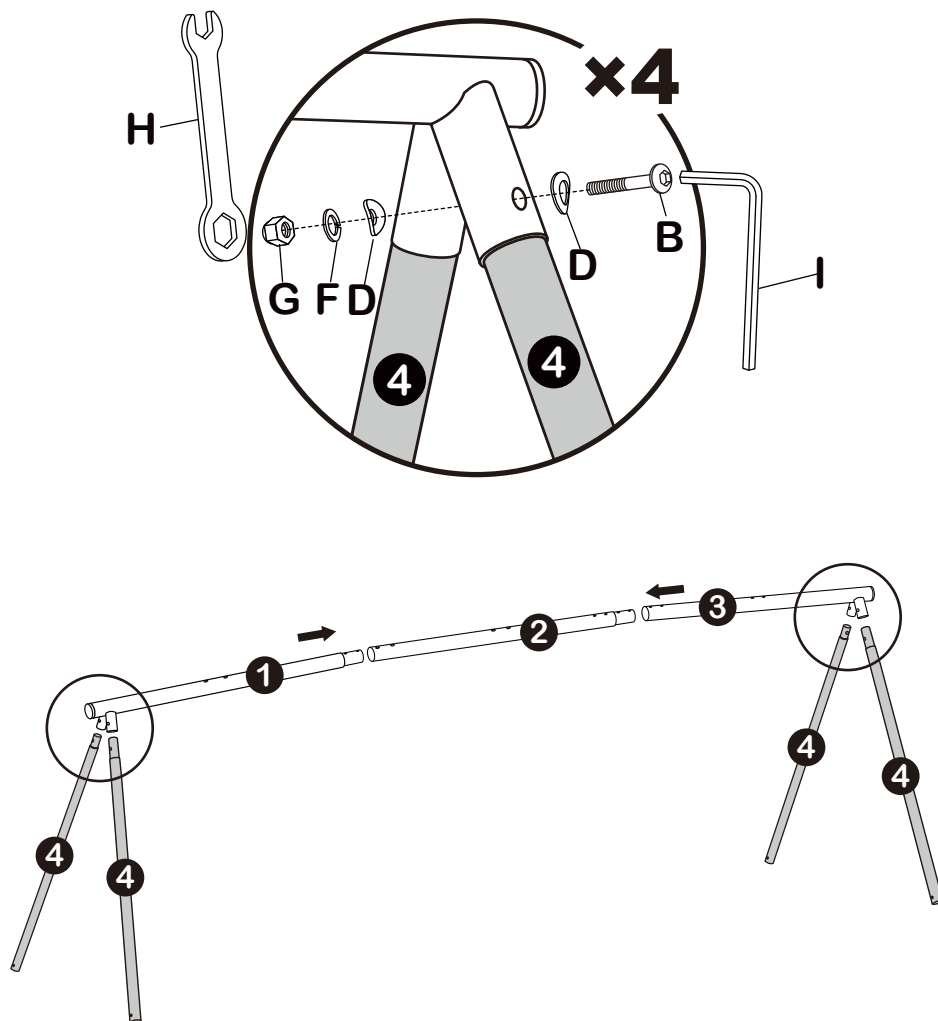





			
B	D	F	G
x4pcs	x8pcs	x4pcs	x4pcs

Figure 1

Assembly Instructions

Step 2

Attach Swing Seat (11),
Monkey Bars (9) and Button
Swing (8) to the top bars as
shown in Figure 2.

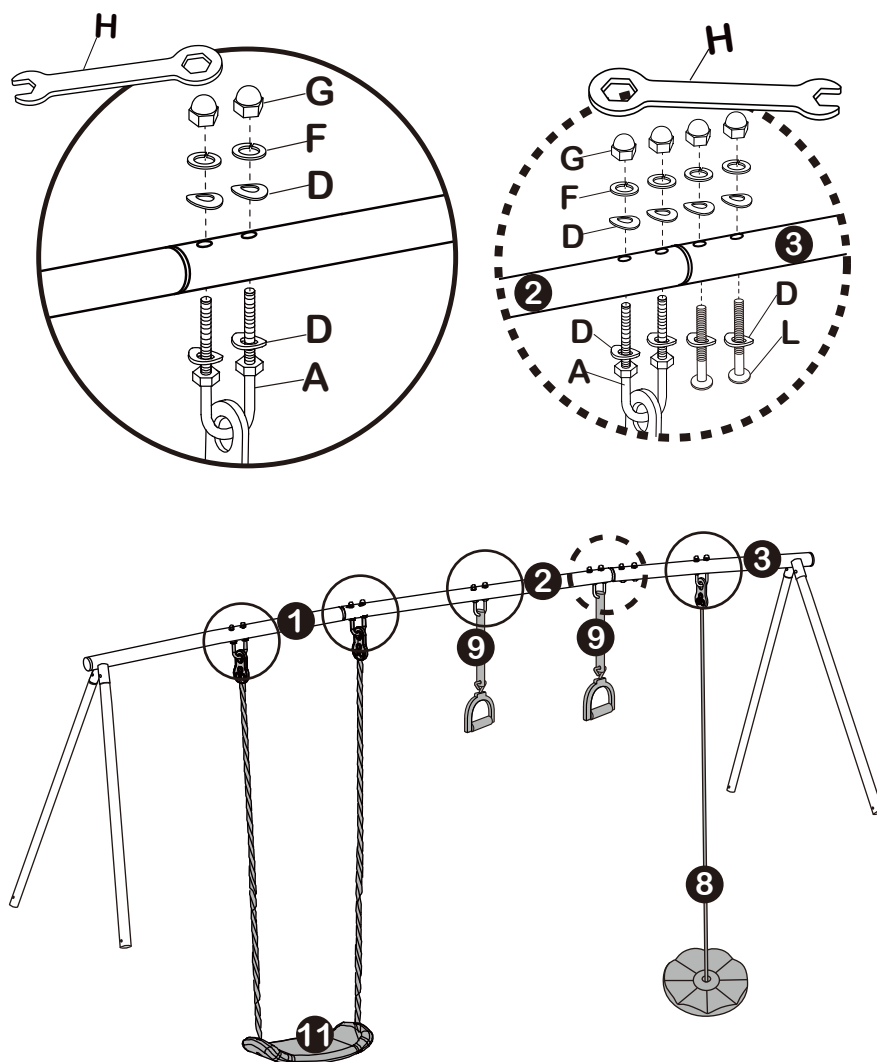

A	L	D	F	G
x5pcs	x2pcs	x24pcs	x12pcs	x12pcs

Figure 2

Assembly Instructions

Step 3

Insert Lower Legs (4) into Upper Legs (5) and secure together with Cross Bars (6) as shown in Figure 3.

Note:

- Plastic cap (7) needs to be placed onto Cross Bar (6) before securing the bolt.
- Cross bars need to be attached to the outer sides of the swing frame.

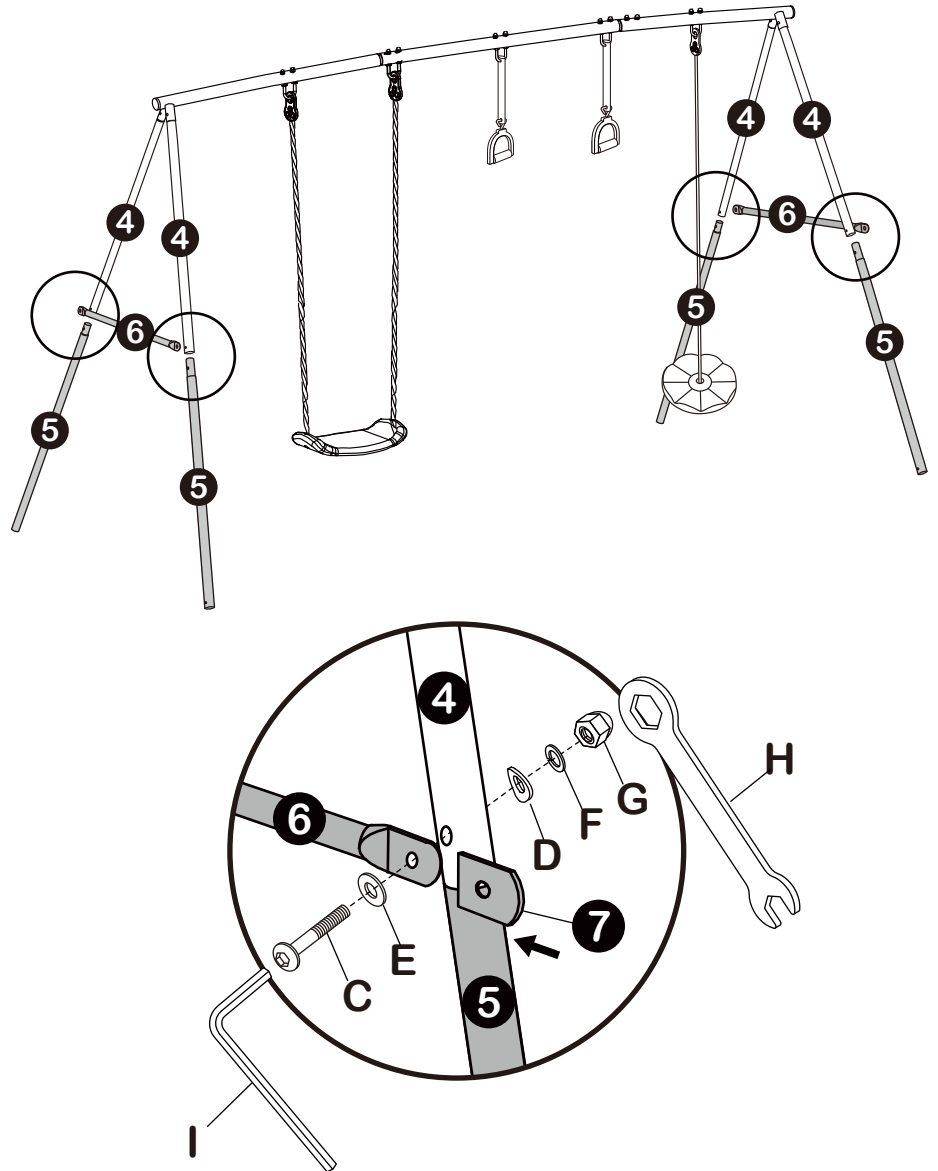





				
C	E	D	F	G
x4pcs	x4pcs	x4pcs	x4pcs	x4pcs

Figure 3

Assembly Instructions

Step 4

Attach Anchors (10) to the Lower Legs (5) as shown in Figure 4.

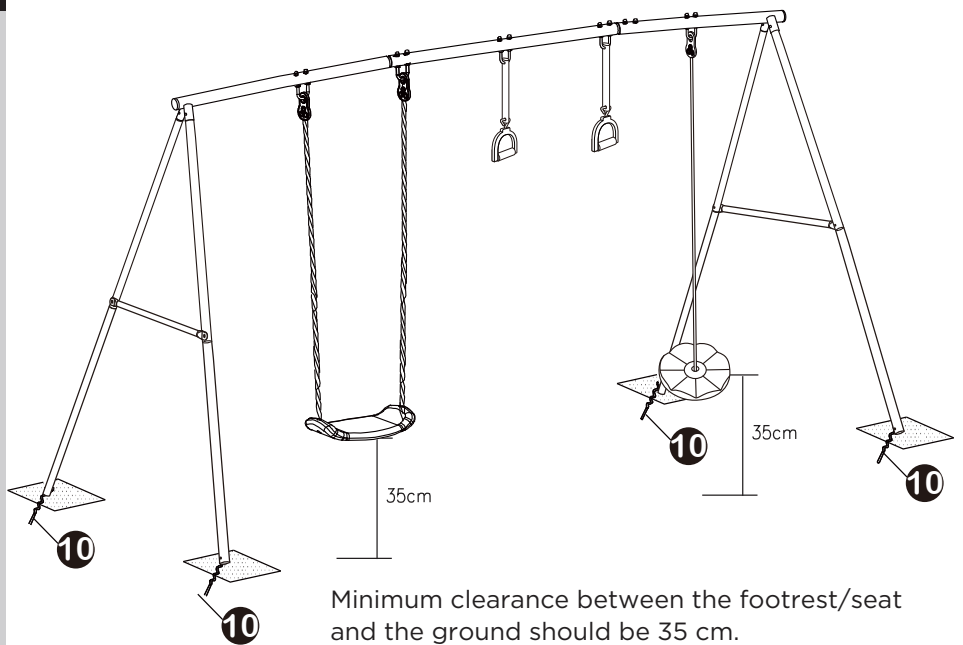

IMPORTANT: The product must be anchored into the ground. For optimum safety and performance, we recommend concreting in the corners as shown in the diagram.

Figure 4

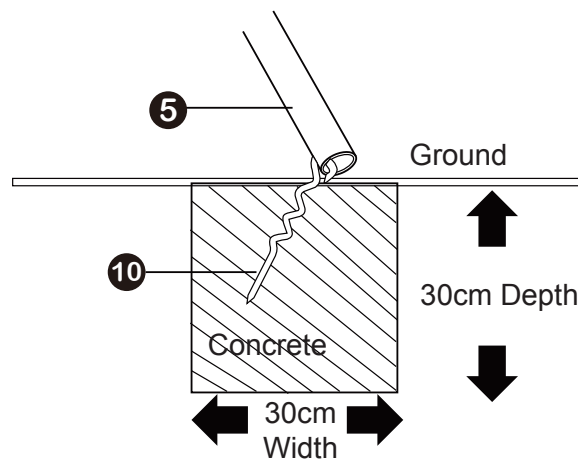
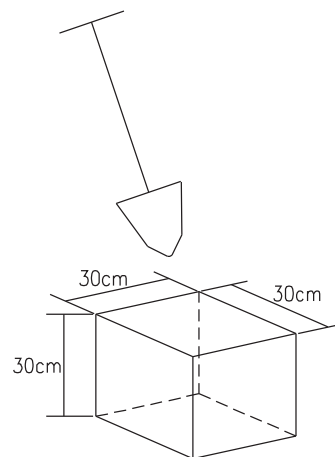

Assembly Instructions

SEAT ADJUSTMENT GUIDE

The length of the rope is adjustable to accommodate the height of the child.

To adjust, loosen the knot on the seat connector, pull rope through the hole to the appropriate length and re-tie the knot again.

Make sure that the knots are tight and that both ropes are adjusted evenly so that the seat is horizontal.

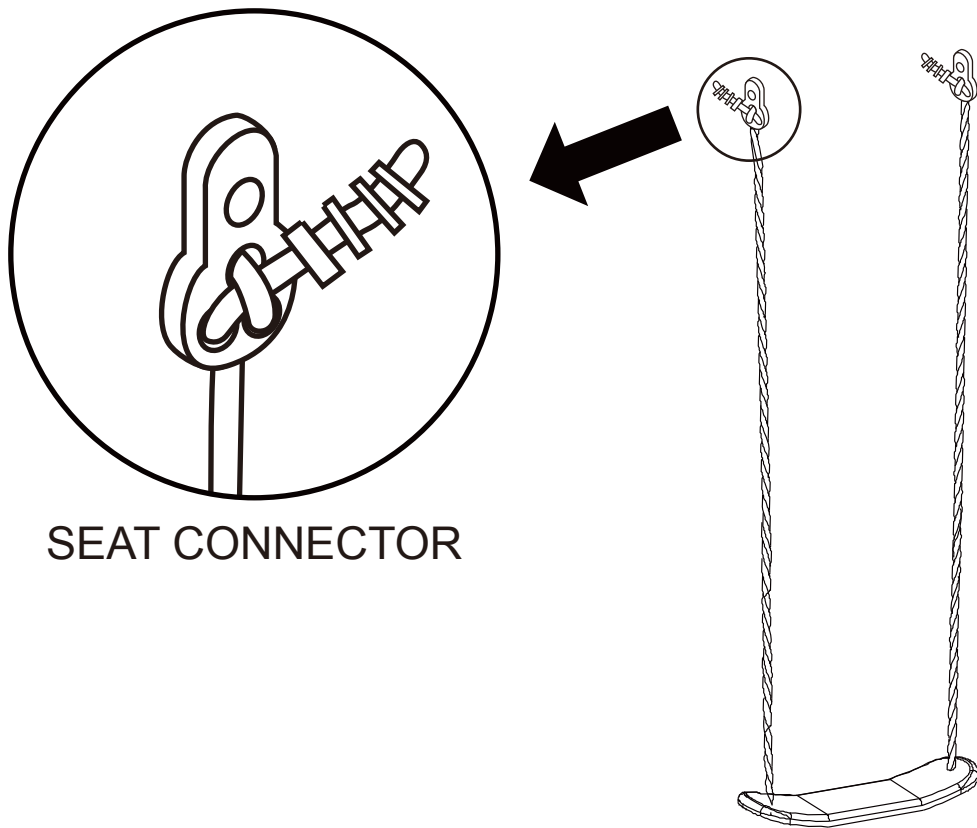

Care and Maintenance

General

This multi play set was designed and manufactured with quality materials and craftsmanship.

If correct care and maintenance is taken, it will provide users with longer usage for exercise, fun and enjoyment.

Inspect regularly for:

- CHECK ALL NUTS AND BOLTS TWICE MONTHLY DURING THE USAGE SEASON FOR TIGHTNESS AND TIGHTEN AS REQUIRED. IT IS PARTICULARLY IMPORTANT THAT THIS PROCEDURE BE FOLLOWED AT THE BEGINNING OF EACH SEASON.
- Never use pliers to tighten up screws –these can cause damage to both the paintwork and the special anti-corrosion plating.
- Tighten all nuts and bolts securely. Replace as needed. If not checked regularly, bolts can be loose or missed and components can become detached and cause injuries.
- Check the unit at the beginning of the usage season and monthly thereafter for evidence of deterioration.
- Immediately remove and replace any items that appear to be weak or broken. Contact Customer Support for replacement parts.
- Check all covers designed for bolts and sharp edges regularly to be certain they are present and in good condition. Replace as needed. It is particularly important that all covers are checked prior to the first use each season.
- Inspect handle bar, hardware, and etc., for proper closure and for signs of wear, deterioration, rust and/or damage. Replace as needed.
- Lubricate all metallic moving parts monthly during the usage season. Applying a light coat of automobile wax to all metal tubing surfaces will help protect your unit and add to its longevity. Sand any rusted areas of the metal tubing and repaint using a non-lead based paint.
- Remove plastic seats and store indoors, or do not use when the temperature drops below 32°F/0°C.
- Check unit for scuffs, burrs, sharp edges and any other defects that may occur from assembly, abuse, shipping or everyday use. Burrs and sharp edges may be filed down until smooth and covered with duct tape if necessary.
- To help maintain the products appearance, occasionally clean the seats and metal framework with a damp cloth lightly – but DO NOT use abrasive chemical cleaners.
- When the time comes to disassemble and dispose of this product, please completely disassemble the unit and discard of it in a safe place and manner so as not to present any hazard to any individual. New paragraph is important to check and maintain the main parts at regular intervals.If these checks are not carried out,the product could overturn or otherwise become a hazard.Whenever practical,the instructions shall also be affixed to the product.
- **IMPORTANT!KEEP FOR FUTURE REFERENCE.**

WARNING!

Ensure product is properly anchored to the ground before use. For outdoor use only. To be played in an open area with adult supervision. Maximum weight per seat is 45kg with a maximum combined weight of 135kg on all components. This unit is designed for a maximum of 3 children. For family domestic use only. As an extra precaution, check this product regularly for signs of wear or damage. Packaging materials are not product. Please remove all packaging and packing tags/wires before allowing children to use. Maintenance to be carried out under the direct supervision of a responsible adult. Colour, designs and decorations may vary from those shown in the photographs.



WARNING! Not suitable for children under 3 years due to small parts, choking hazard.



If you need help or have damaged or missing parts, call the Customer Helpline:(+44) 0330 0904 420

Produced for Chad Valley Toys. Argos Ltd. Country of origin: China

Address: 489 - 499 Avebury Boulevard, Central Milton Keynes, MK9 2NW. www.argos.co.uk