

8ft (2.40 m) Trampoline and Enclosure

Assembly, Installation, Care, Maintenance and User Instructions

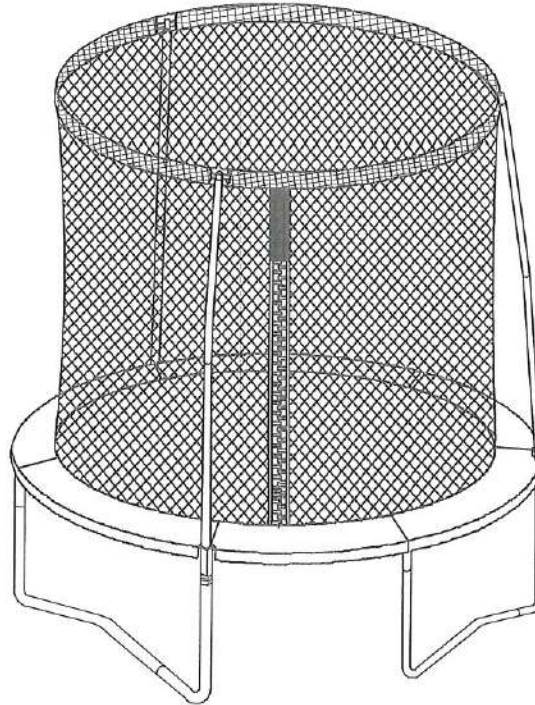

Assembly Size: $\Phi 240 \times 205\text{cm}$



DANGER

- DO NOT attempt somersaults or flips. Paralysis or death can result if you land on your head or neck!
- No more than one person on the trampoline at a time. Multiple users increase the risk of injury.
- Use trampoline only with mature and knowledgeable supervision.

WARNING

- **These instructions are important to minimise chances of injury. Please read each of them thoroughly before you assemble and use this trampoline. Retain this manual for future reference.**
- Maximum weight of the user shall NOT exceed 110lbs/50kg for this product.
- Do not allow children under 3 years old nearby during assembly. Small parts – choking hazard!
- Assembly by two adults required. Estimated time: 2 hours.
- Domestic and outdoor use only.
- Constant adult supervision required.

DO NOT RETURN PRODUCT TO THE STORE. FOR CUSTOMER SERVICE OR REPLACEMENT PARTS, PLEASE CALL 0330 0904 420 or email to support@sportspower.biz

DANGER

WARNING



NO SOMERSAULTS OR FLIPS – PARALYSIS OR DEATH can result if you land on your head or neck!



No more than ONE user at a time (maximum weight - 110lbs/50kg).



Do not use if in a cast or have previous leg, arm, head, neck or back injury.



Do not allow children under three (3) years old nearby during assembly.



Remove all hard or sharp objects including jewelry, eyeglasses, sunglasses or hairclips before jumping.



Do not use without the consent of your physician, if pregnant.

Daily Pre-Inspection:

- >Inspect legs for proper attachment or cracks
- >Inspect netting for tears and sagging
- >Inspect for loose or damaged springs
- >Inspect mat for tears or worn stitching
- >Inspect frame for sagging or cracks

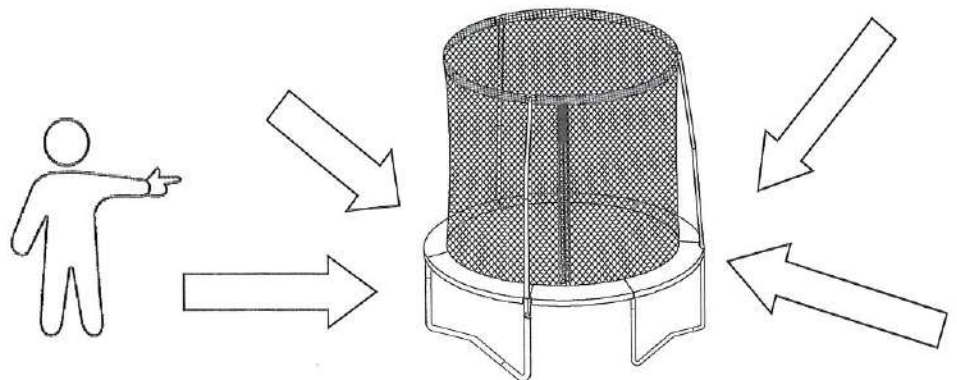

Inspect prior to use – check that the legs are properly attached and stable on the ground; no loose springs; mat and enclosure net are in proper place and in good condition with no tears.

INTRODUCTION

Thank you for purchasing a Sportspower product! This trampoline was designed and manufactured with quality materials and craftsmanship, providing fun and exercise in the enjoyment of your own backyard.

It is very important that the owners and users of this trampoline have adequate knowledge of techniques and rules for proper use. In particular, children must be supervised at all times by a knowledgeable and mature adult while using the trampoline. Take precautions to prevent access to the trampoline by children when there is no adult supervision. Also restrict access to any unauthorized users without your consent.

Carefully read and understand all of the instructions and warnings in the User Manual before assembling and using this product. It is the responsibility of the owner of this trampoline to ensure that all users of this product are fully informed on the proper use and the inherent risks of jumping on a trampoline. Failure to do so can result in serious injury or death. In particular, under no circumstances should you attempt or allow flips, somersaults or any similar conduct. Landing on the head or neck can cause serious injury, paralysis, or death, even when landing in the middle of the mat. Also, do not allow more than one person on the trampoline under any circumstances. Use by more than one person at the same time increases the chance of injury.

To reduce risks associated with users falling off the trampoline, enclosure netting must be properly installed and used at all times. The trampoline enclosure must be closed during use to prevent the user from falling off the trampoline. Your trampoline enclosure netting is manufactured with UV resistant material. Despite this, exposure to harsh elements (sunlight, wind, moisture, animals, etc) will weaken the netting. The netting and mat must be inspected prior to every use and maintained regularly as detailed in this User's Manual.

Please also ensure proper placement of this product to avoid injuries. It is essential that the intended site for this trampoline is completely flat and level. If the ground is uneven, this could cause movement in the frame and stress on the joined sections of the frame that could damage the trampoline and/or can cause serious injury. Do not position this trampoline on hard surface such as concrete, tarmac or paving. Suitable surfaces include flat dirt or grass, sand or play area covered with an appropriate depth of play bark material, with no obstructions above, below or near the product.

The product must not be used in windy conditions as wind can cause unexpected movement of the product. Wind can cause the trampoline to be lifted off the ground and become airborne. This can present a danger to individuals and to property. Winds can be especially strong in open areas, foothills, mountains, locations subject to hurricanes and tornadoes, areas between homes that create wind tunnels and anywhere else where local weather conditions can create high winds. We recommend that you anchor the trampoline or otherwise secure the trampoline to prevent it from moving as a result of the wind. One possible way to anchor the trampoline is to secure the trampoline to a concrete footing under each leg. We recommend consulting a local licensed contractor to best determine how the anchor system should be constructed for your specific conditions. The licensed contractor can also advise you of other options such as below ground installation. Even with anchors, a trampoline can be lifted, just like anything else, by strong winds. If the winds are anticipated to be very strong, the trampoline should be disassembled and stored away safely until the weather conditions improve. Damage from the wind or other severe weather is not covered by the manufacturer's warranty. Because the manufacturer warranty does not cover wind or weather related damage and damage can be caused to your property or the property of others by a windblown trampoline, it is strongly advised that you provide site specific anchoring through a licensed local contractor.

Only genuine Sportspower placement parts sold through our authorized dealer are recommended. Replacement parts from other sources may not have been designed, tested or manufactured to Sportspower standards. Because of this, Sportspower cannot guarantee the performance and safety of the product when non genuine replacement parts are used. The use of non-genuine Sportspower replacement parts may affect any warranty claim on the product, as allowed by the law in your jurisdiction.

DANGER

- Use trampoline only with mature, knowledgeable adult supervision.
 - Do not attempt or allow somersaults. Landing on the head or neck can cause serious injury, paralysis, or death, even when landing in the middle of the mat.
 - Do not allow more than one person on the trampoline. Use by more than one person at the same time increases the chance of injury.
-

Before you start to assemble	1
Before using the product... ..	1
Important Warnings	2-5
Important Instructions for Enclosure Netting and Mat	6-7
Trampoline and Enclosure Parts List	8-9
Assembly and Installation Instructions	10
Trampoline Frame Assembly.....	11-12
Trampoline Mat Assembly	13-17
Frame Pad Placement.....	18
Trampoline Enclosure Assembly	19-22
Final Assembly	23
Disassembly of the Trampoline and Enclosure	24
Moving the Trampoline and Enclosure.....	24
Care and Maintenance.....	25
Proper Use Instructions	26-27
Learning the fundamental trampoline skills	28-29
Product Warranty	30-31

DANGER

- Use trampoline only with mature, knowledgeable adult supervision.
 - Do not attempt or allow somersaults. Landing on the head or neck can cause serious injury, paralysis, or death, even when landing in the middle of the mat.
 - Do not allow more than one person on the trampoline. Use by more than one person at the same time increases the chance of injury.
-

WARNING

Carefully read and understand all of the instructions and warnings in this manual before assembling and using this product. It is the responsibility of the owner of this trampoline to ensure that all users of this product are fully informed on the proper use and the inherent risks of jumping on a trampoline. Failure to do so can result in serious injury or death.

Before you start to assemble...

- Check the package and make sure you have all of the parts listed in the Parts List section of this user manual. **IF ANY PARTS ARE MISSING**, please call the Customer Service number listed on the cover page for assistance.
- Do not install or use the product if any parts are missing or damaged. Store in a safe place until ready to install.
- Make sure that you have plenty of space and a clean dry area suitable for the assembly of this trampoline. **IT IS ESSENTIAL THAT THE INTENDED SITE FOR THIS TRAMPOLINE IS COMPLETELY FLAT AND LEVEL.** Adequate overhead clearance is essential. A minimum of 8 meters from ground level is recommended. Provide clearance for wires, tree limbs, and other possible hazards. Always ensure the trampoline is on level ground with a minimum of 2 meters clear space from any structure or obstruction. If the ground is uneven, this could cause movement in the frame and stress on the joined sections of the frame that could damage the trampoline and/or can cause serious injury.
- Two adults are needed to assemble this trampoline.
- Heavy gloves must be used to protect your hands from pinch points during assembly and goggles must be worn to avoid injuries to the eyes.
- Never modify the construction or the design of the product. Do not use any unauthorised Sportspower parts with this trampoline.
- This pack may contain small parts and is not suitable for children under three (3) years of age to be nearby during assembly. Small parts. Choking hazard.
- **IMPORTANT:** Save this manual for future reference.

Before using the product...

- Use of this trampoline requires constant adult supervision. Use the trampoline only with mature and knowledgeable **ADULT** supervision.
- Ensure that the trampoline enclosure has been assembled correctly, as per the instructions in this manual and that the zipper and buckles located at the entrance are fully closed before use.
- Trampolines over 20 in. (51 cm) tall are not recommended for use by children under 6 years of age.
- There must be no more than one person at a time on the trampoline.
- Maximum weight of the user shall NOT exceed 110lbs/50kg for this product.
- This product is for household and family domestic use only – It is not for use in schools, playgrounds, rental or commercial use.
- It is of particular importance to follow the maintenance instructions at the beginning of every season. Neglecting regular maintenance can lead to a risk for users.

! DANGER

- Use trampoline only with mature, knowledgeable adult supervision.
- Do not attempt or allow somersaults. Landing on the head or neck can cause serious injury, paralysis, or death, even when landing in the middle of the mat.
- Do not allow more than one person on the trampoline. Use by more than one person at the same time increases the chance of injury.

Important Warnings

Carefully read these warnings before using this product. Failure to follow these warnings can result in serious injury or death.

! DANGER

- Only one user at any one time! Multiple users can cause loss of control, collision or falls on the trampoline. This could result in serious injury to legs, arms, back, neck or head.
- Do not use the trampoline when under the influence of alcohol, drugs or medication, which may impair the jumper's judgement.
- Always consult your physician before performing any kind of physical activity.
- Do not use the trampoline if you have high blood pressure.
- Do not use the trampoline if you have a medical history of neck or back injuries or mental or physical conditions that could cause injury.
- Do not use if the user has any broken bones (casts) or has recently been in the hospital for extensive treatments (operations, severe wounds, stitches, back injury or concussion).
- Do not use without the consent of your physician, if pregnant.
- Do not use the trampoline during windy conditions or if the user or the trampoline surface is wet. These conditions can cause the user to lose control and fall resulting in serious injury.
- The product must not be used in windy conditions as wind can cause unexpected movement of the product. Wind can cause the trampoline to be lifted off the ground and become airborne. This can present a danger to individuals and to property. Winds can be especially strong in open areas, foothills, mountains, locations subject to hurricanes and tornadoes, areas between homes that create wind tunnels and anywhere else where local weather conditions can create high winds. We recommend that you anchor the trampoline or otherwise secure the trampoline to prevent it from moving as a result of the wind. One possible way to anchor the trampoline is to secure the trampoline to a concrete footing under each leg. We recommend consulting a local licensed contractor to best determine how the anchor system should be constructed for your specific conditions. The licensed contractor can also advise you of other options such as below ground installation. Even with anchors, a trampoline can be lifted, just like anything else, by strong winds. If the winds are anticipated to be very strong, the trampoline should be disassembled and stored away safely until the weather conditions improve. Damage from the wind or other severe weather is not covered by the manufacturer's warranty. Because the manufacturer warranty does not cover wind or weather related damage and damage can be caused to your property or the property of others by a windblown trampoline, it is strongly advised that you provide site specific anchoring through a licensed local contractor.

⚠ DANGER

- Use trampoline only with mature, knowledgeable adult supervision.
- Do not attempt or allow somersaults. Landing on the head or neck can cause serious injury, paralysis, or death, even when landing in the middle of the mat.
- Do not allow more than one person on the trampoline. Use by more than one person at the same time increases the chance of injury.



Carefully read these warnings before using this product. Failure to follow these safety instructions can result in serious injury or death.

⚠ WARNING**Proper Play Conditions:**

- Always use the product in a well-lit area. Do not use without lighting during dawn, dusk or in complete darkness!
- The trampoline must be placed on a surface that is **COMPLETELY FLAT AND LEVEL**. If the ground is uneven, this could cause movement in the frame and could cause stress on the joined sections of the frame that could damage the trampoline and/or can cause serious injury.
- DO NOT install or position this trampoline on a hard surface such as concrete, tarmac or paving. Suitable surfaces are grass, sand or a play area covered with an appropriate depth of play bark material.
- ALWAYS ensure the trampoline is on level ground with a minimum of 6.6ft (2 metres) clear space from any structure or obstruction such as fence, garage, house, overhanging branches, laundry lines or electrical wires.
- Adequate overhead clearance is essential. A minimum of 26.25 ft (8 metres) from ground level is recommended. Provide clearance for wires, tree limbs, and other possible hazards.
- Do not use the trampoline indoors, as this product is intended for outdoor home use only.
- The product must not be used in windy conditions as wind can cause unexpected movement of the product. Wind can cause the trampoline to be lifted off the ground and become airborne. This can present a danger to individuals and to property. Winds can be especially strong in open areas, foothills, mountains, locations subject to hurricanes and tornadoes, areas between homes that create wind tunnels and anywhere else where local weather conditions can create high winds. We recommend that you anchor the trampoline or otherwise secure the trampoline to prevent it from moving as a result of the wind. One possible way to anchor the trampoline is to secure the trampoline to a concrete footing under each leg. We recommend consulting a local licensed contractor to best determine how the anchor system should be constructed for your specific conditions. The licensed contractor can also advise you of other options such as below ground installation. Even with anchors, a trampoline can be lifted, just like anything else, by strong winds. If the winds are anticipated to be very strong, the trampoline should be disassembled and stored away safely until the weather conditions improve. Damage from the wind or other severe weather is not covered by the manufacturer's warranty.
- Keep open fire, camp fire, BBQ fire pit or firecracker away from the trampoline.
- Do not allow fire amber or spark to land on the trampoline.

! DANGER

- Use trampoline only with mature, knowledgeable adult supervision.
 - Do not attempt or allow somersaults. Landing on the head or neck can cause serious injury, paralysis, or death, even when landing in the middle of the mat.
 - Do not allow more than one person on the trampoline. Use by more than one person at the same time increases the chance of injury.
-



Carefully read these warnings before using this product. Failure to follow these safety instructions can result in serious injury or death.

! WARNING**Appropriate Use Conditions:**

- Children must always be supervised while they are playing on the trampoline and must be instructed not to use the trampoline in an inappropriate or hazardous manner. Take precautions to prevent access to the trampoline by children when there is no adult supervision.
- Restrict access to the trampoline by any unauthorized users without your consent.
- Trampolines are rebounding devices, which propel the user to unaccustomed heights, and into a variety of body movements. Rebounding off of the trampoline, striking the frame or springs, or improperly landing on the trampoline mat may cause serious injury.
- Always start and maintain your jump at the center of the trampoline mat in order to reduce the risk of landing on the frame or springs or falling off the trampoline.
- Avoid bouncing too high. Stay low until you can control your bounce and land consistently in the middle of the trampoline mat.
- Ensure the trampoline frame and springs are fully covered by the frame pad to avoid any direct contact with metal parts.
- Do not stand or jump on the springs while using the trampoline. The springs are not designed to support such stress and weight. This can result in serious injuries and/or product damage. If you see any signs of stretched or damaged springs, do not use the trampoline until replacement springs are properly installed. Please contact our customer service representatives to order original Sportspower replacement parts.
- The trampoline is several feet off the ground. Jumping off the trampoline to the ground or any other surface may result in injury. Smaller children may need assistance getting up onto or down from the trampoline. Mounting and dismounting properly should be followed as a strict rule. Users should climb onto the trampoline by placing their hands on the frame and stepping or rolling up onto the frame, across the springs and onto the mat. Do not step directly on the frame pad or grasp the frame pad when mounting or dismounting the trampoline. To dismount, jumpers should walk to the side of the mat, bend over and place their hands on the frame, then step from the mat to the ground. Users should always place their hands on the frame while mounting or dismounting.
- Do NOT use the trampoline as a springboard to jump onto other objects.
- Remove all objects not designed for use with the trampoline from the trampoline before use. Do not let children take toys or other items onto the trampoline.
- Do not eat while jumping.
- The trampoline should not be buried or sunken into the ground.
- During winter period, the snow load and the very low temperature can damage the trampoline. It is recommended to remove the snow and store the mat and the enclosure indoor.

! DANGER

- Use trampoline only with mature, knowledgeable adult supervision.
- Do not attempt or allow somersaults. Landing on the head or neck can cause serious injury, paralysis, or death, even when landing in the middle of the mat.
- Do not allow more than one person on the trampoline. Use by more than one person at the same time increases the chance of injury.



Carefully read these warnings before using this product. Failure to follow these safety instructions can result in serious injury or death.

! WARNING

- Do not jump or step onto the frame pad as it was not designed to support the weight of a person.
- Do not use the trampoline while holding or wearing any type of sharp or pointed objects such as jewelry, watches, rings, eyewear and necklaces before using this product. This will prevent the jewelry from tearing the mat or getting caught in the enclosure netting.
- Do not wear loose fitting clothing that may catch or snag during play.
- Never wear footwear (e.g. shoes) when using the trampoline.
- Always tie back long hair so that it does not block user's vision or get caught in the enclosure netting.
- **FRAME PADS** – Frame pads are there to protect user from any fall or landing on the springs and frame. On no account should people be permitted to sit or stand on them when the trampoline is in use. You should also make sure that smaller users do not use the inside edges of the pads as a "handle" when getting up on to the trampoline.
- Never use the trampoline without the frame pad being securely attached. Properly tie down the frame pad before each use. Improper assembly of the frame pad may lead to injury!
- Always check to ensure there are no obstructions or objects under the trampoline that could cause injury or obstruct movement of jump mat. Also check that there are no pets or other people underneath the trampoline.
- Do not jump on the trampoline with a snowboard, skateboard, roller blades, bicycle or any other equipment. **DO NOT** hold any foreign objects not authorized by the manufacturer in your hand and **DO NOT** place any objects on the trampoline while anyone is jumping on it. Please be aware of your surroundings to ensure there are no objects that could cause harm when you are playing on the trampoline.
- The frame of your trampoline is made of steel and it will conduct electricity. No electrical equipment (lights, heaters, extension cords, household appliances, etc.) should be permitted in or on the enclosure under any circumstances to avoid the risk of electrocution.
- Always jump in the middle of the mat.

Enclosure Netting and Mat – Appropriate Use Conditions

- Children **MUST NEVER** be left unattended inside the enclosure at any time.
- The enclosure is **ONLY** intended to be used to reduce the risk of injury from falling off the trampoline. Do not intentionally kick, bounce against, climb on, hang from, jump over or crawl under the netting.
- Enter and exit the enclosure only through the zipper door. Do not go through the gap between the netting and the mat. Trying to exit this way poses a risk of strangulation, especially for young children.
- The enclosure netting and mat must be inspected prior to each use. If there are any signs of weakness, you must stop using the trampoline immediately, properly store the trampoline and restrict access by users until a new Sportspower authorized replacement netting or pad is installed. Please refer to the Trampoline Net & Pad – Maintenance Requirements section contained in this manual for further details.

Important Instructions for Enclosure Netting and Mat



Failure to follow these instructions to ensure proper operational condition of your trampoline may lead to serious injury or death.

1. Maintenance of Trampoline Enclosure Net, Mat and Pad

Enclosure nets and padding are prone to wear and tear like tires on a car. Gradual deterioration of the material will occur; the speed of which will depend on the level of exposure to UV rays, airborne pollution and outdoor weather conditions such as rain and wind.

The net and padding needs to be properly maintained and checked by following the Maintenance Schedule set out in these instructions. When the material shows any signs of weakness, you must stop using the trampoline immediately, properly store the trampoline and restrict access by users until a new replacement net or padding is properly installed.

2. Maintenance Requirement for Enclosure Net

Your trampoline enclosure netting is manufactured with UV resistant material. Despite this the netting is exposed to the outdoor elements including sunlight, wind, rain and wildlife. The net surrounding the trampoline must be checked prior to each use. This includes, but is not limited to inspecting the net for cracks, excess wear, brittleness, and stretching. Also inspect all connections and the entire enclosure for overall integrity. The net must be immediately replaced if it shows any signs of wear, damage, stretching, cracking, looseness, brittleness or other losses in integrity. The following Maintenance Schedule must be followed:

1 to 3 Months	3 to 6 Months	6 to 12 Months
Inspect the enclosure (net, net hanger, and straps) prior to every use.	Thorough inspection for UV damage and prior to every use for net, net hanger and straps.	Thorough inspection before every use on net, net hanger, straps, zippers, ties and strings. Replace after 12 months or earlier if necessary.

IT IS RECOMMENDED THAT THE NET BE REPLACED ON A YEARLY BASIS UNDER NORMAL USE, EVEN IF IT DOES NOT SHOW ANY VISIBLE SIGNS OF DAMAGE.

IMPORTANT INSTRUCTIONS FOR ENCLOSURE NETTING AND MAT

How to Inspect the Trampoline Net for Proper Use

Always check the enclosure netting for signs of UV damage, deterioration, brittleness, cracking, and tearing every time before using the trampoline and enclosure.

Step 1 - Inspect the enclosure netting before **EACH** use for wear or tear by pinching and pulling a section of the netting between fingers and pulling downward. Please see diagram below.

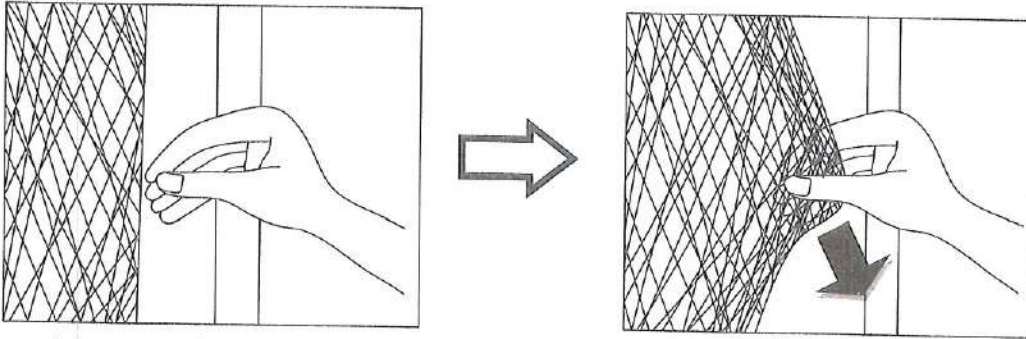

If it produces any tear or cracking or ripping sound, then the net is unsafe and **MUST** be taken down immediately. **STOP USING THE TRAMPOLINE ENCLOSURE IF YOU FIND ANY SIGNS OF WEAR OR TEARING ON THE NETTING.**









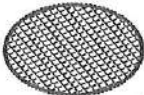

Step 2 - Walk around the whole perimeter of the trampoline to visually check for material deterioration or other damage.

3. Maintenance Requirement for Trampoline Pad

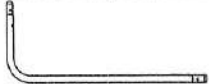
Walk around the whole perimeter of the trampoline to visually check for material deterioration, tears, looseness, loss of elasticity or other damage in the pad.







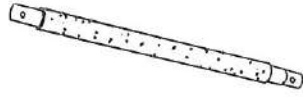
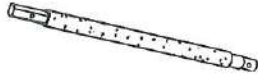
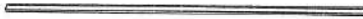
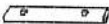

It is recommended that you replace the trampoline enclosure net and pad every 12 months. Replace the enclosure net and pad earlier if there are any signs of wear, tear, brittleness, cracking, stretching or any other signs of weakness. New enclosure netting and pad can be purchased through Sportspower'S authorized service center.

Trampoline and Enclosure Parts List

Key Number	Diagram	Description	Quantity
1		Trampoline Mat, stitched with Triangle-Rings	1
2		Frame Pad	1
3		T-Part	3
4		T-Part with Enclosure Socket	3
5		Top Rail	6
6		Long L-Shaped Leg	3
7		Short L-Shaped Leg	3
8		Galvanized Springs	42
9		Spring Loading Tool	1
10		Allen Wrench	1
11		Trampoline Safety Instruction Placard	1

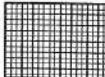
For missing or replacement parts please call 0330 0904 420 or email support@sportspower.biz

Hardware Parts List

Key Number	Diagram	Description	Quantity
A		Upper Frame Tube with Foam	3
B		Lower Frame Tube With Foam	3
C1		Flat Steel Plate	6
C2		Flat Steel Connector	6
D		Wrench	1
E		Self-Locking Screw	6
F		Plastic Cap	3
G		Enclosure Netting	1
H		Bolt	12
I		Nut	12
J		Plastic Cap	3
K		Trampoline Enclosure Safety Instruction Placard	1

For missing or replacement parts please call 0330 0904 420 or email support@sportspower.biz

Assembly and Installation Instructions



Review all steps before assembly and read all precautions before using this product. Failure to do so can result in serious injury or death.

During periods of non-use, this trampoline and trampoline enclosure can be easily disassembled and stored by reversing the order of installation.

WARNING

- At least two people are required to assemble the trampoline and trampoline enclosure.
- Protective gloves must be used during assembly to avoid injuries during installation.
- Protective goggles must be worn to avoid injuries to the eyes.

WARNING

For appropriate use of the trampoline, please assemble the trampoline in a location that meets the following conditions:

- Adequate overhead clearance is needed. A minimum of 26.25 ft (8 meters) from ground level is recommended. Provide clearance for wires, tree limbs and other possible hazards.
- ALWAYS ensure the trampoline is on level ground with a minimum of 2 meters clear space from any structure or obstruction such as fence, garage, house, overhanging branches, laundry lines or electrical wires.
- Place the trampoline on a flat and level surface before use.
- Do not install this trampoline on hard surfaces. Suitable surfaces include grass or sand.
- Use the trampoline in a well-lit area. Artificial illumination may be required for shady areas.
- The trampoline should be installed in an area where access can be restricted from unauthorized and unsupervised use.
- Ensure there is nothing beneath the trampoline that could cause injury or obstruct movement of jump mat.
- The trampoline enclosure is only to be used as an enclosure for a trampoline of a size for which the enclosure is designed.
- The owner and supervisors of the trampoline are responsible to make all users aware of practices specified in the use instructions section.
- Users may become entangled in or strangled by loose cords or in gaps between trampoline and enclosure. Keep enclosure tightly fastened to the trampoline in accordance with the manufacturer's instructions. Failure to properly assemble and maintain a tight, secure trampoline/enclosure boundary may result in serious injury, strangulation, or death.

If you do not follow these guidelines, you increase the risk of injury or death.

PRIOR TO ASSEMBLING

Before assembly, please ensure that you have all the parts required to assemble the product. If you are missing any parts, please contact our Customer Support agents.

NOTICE

- Please do not use unauthorised Sportspower parts to assemble the trampoline. This may damage the integrity of the product and will void the manufacturer's warranty.
- **DO NOT use electric power tools to tighten or loosen bolts and screws as this can damage the hardware.**
- All nuts and bolts must be checked for tightness and if necessary must be retightened.
- All spring-loaded (pit pin) joints must be checked to see that they are still intact and cannot become dislodged during play.
- Check all coverings for bolts and sharp edges and replace them if necessary.
- If self-locking nuts are used, it should be noted that these are only suitable for one assembly and must therefore be replaced.

STEP 1

Layout all parts on clean flat surface as shown below.

Note: make sure to assemble the trampoline where it is intended to be used. The trampoline should not be moved after it is assembled.

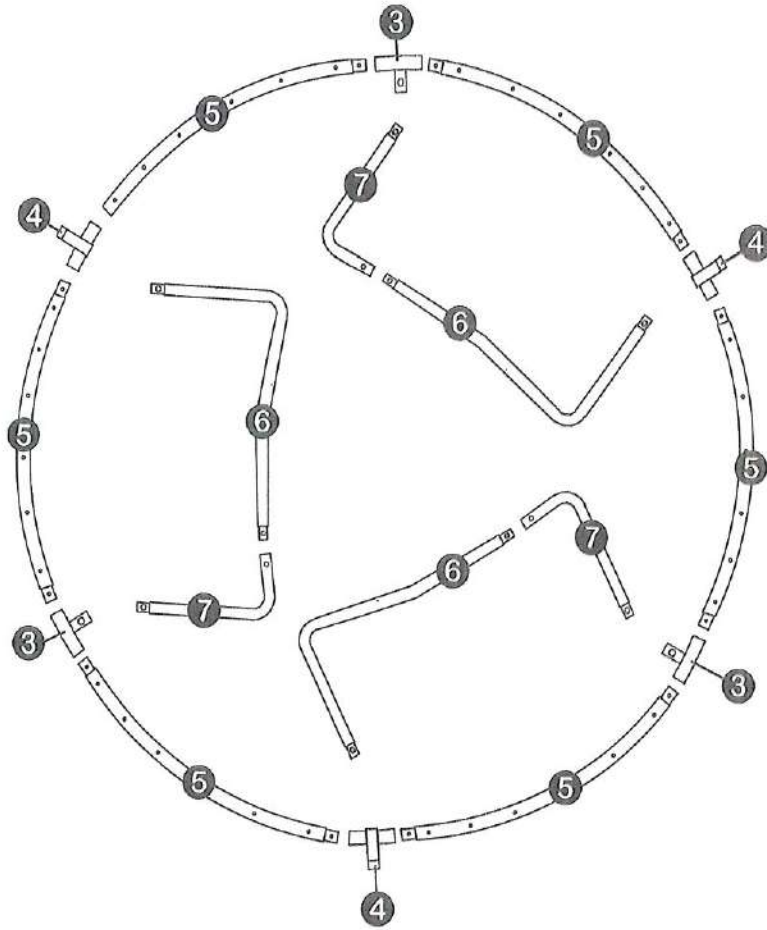

STEP 2

Connect Parts 6 and 7. Repeat to assemble three sets of leg supports.

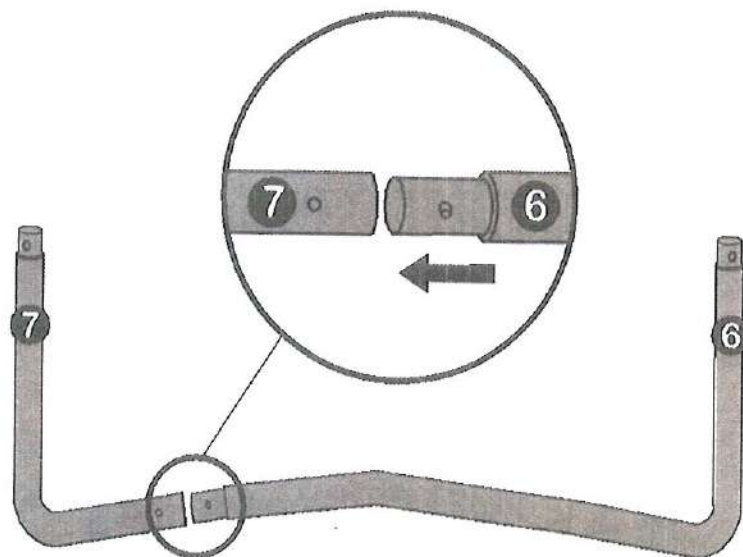

STEP 3

First connect 3, 4 and 5 to form the trampoline frame, then insert the assembled leg supports.

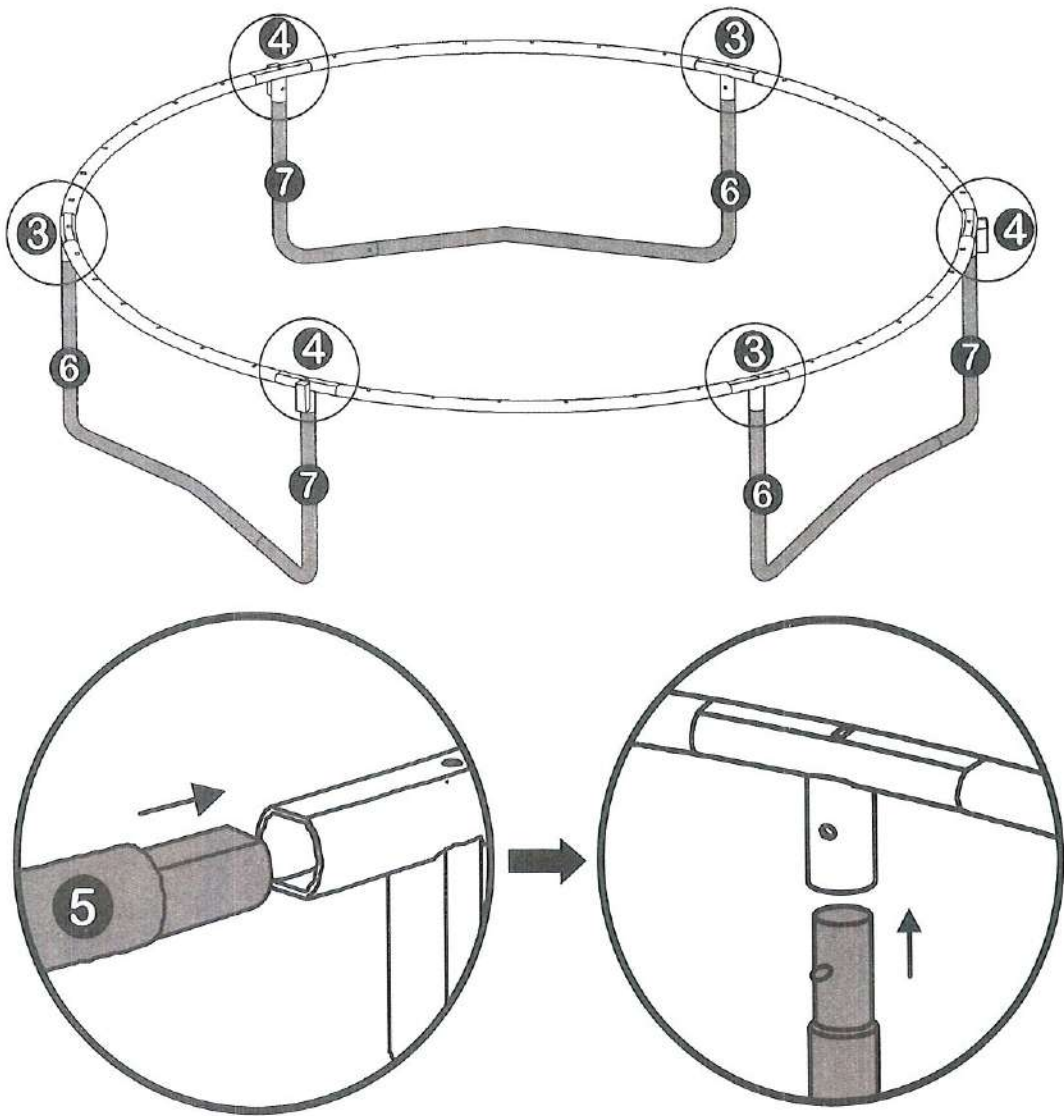

WARNING

DO NOT PLACE HANDS NEAR THE OPENING WHEN CONNECTING THE TUBES. WEAR PROTECTIVE GLOVES TO PROTECT FROM INJURIES DURING ASSEMBLY.

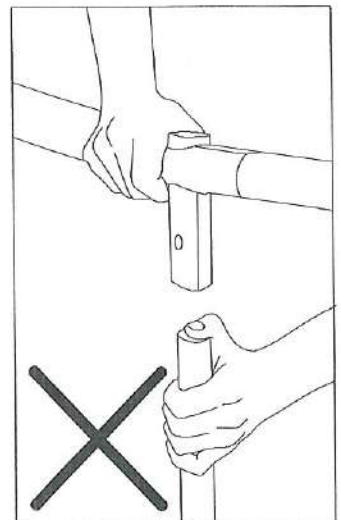
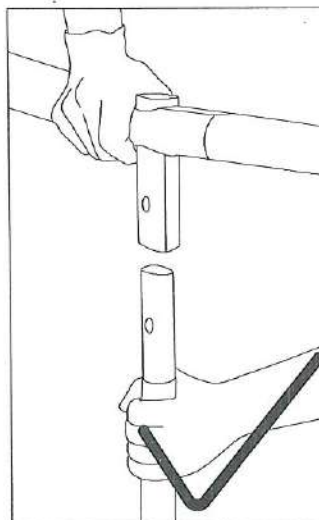
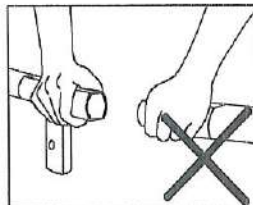
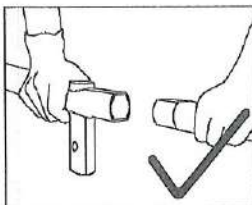

STEP 4

Lay out the mat on clean flat surface. Place the enclosure netting on top of the mat and pull the triangle rings on the mat through the slots in the enclosure netting.

IMPORTANT NOTE: Make sure the warning label on the mat is located in front of the zipper so it is visible to the user when entering.

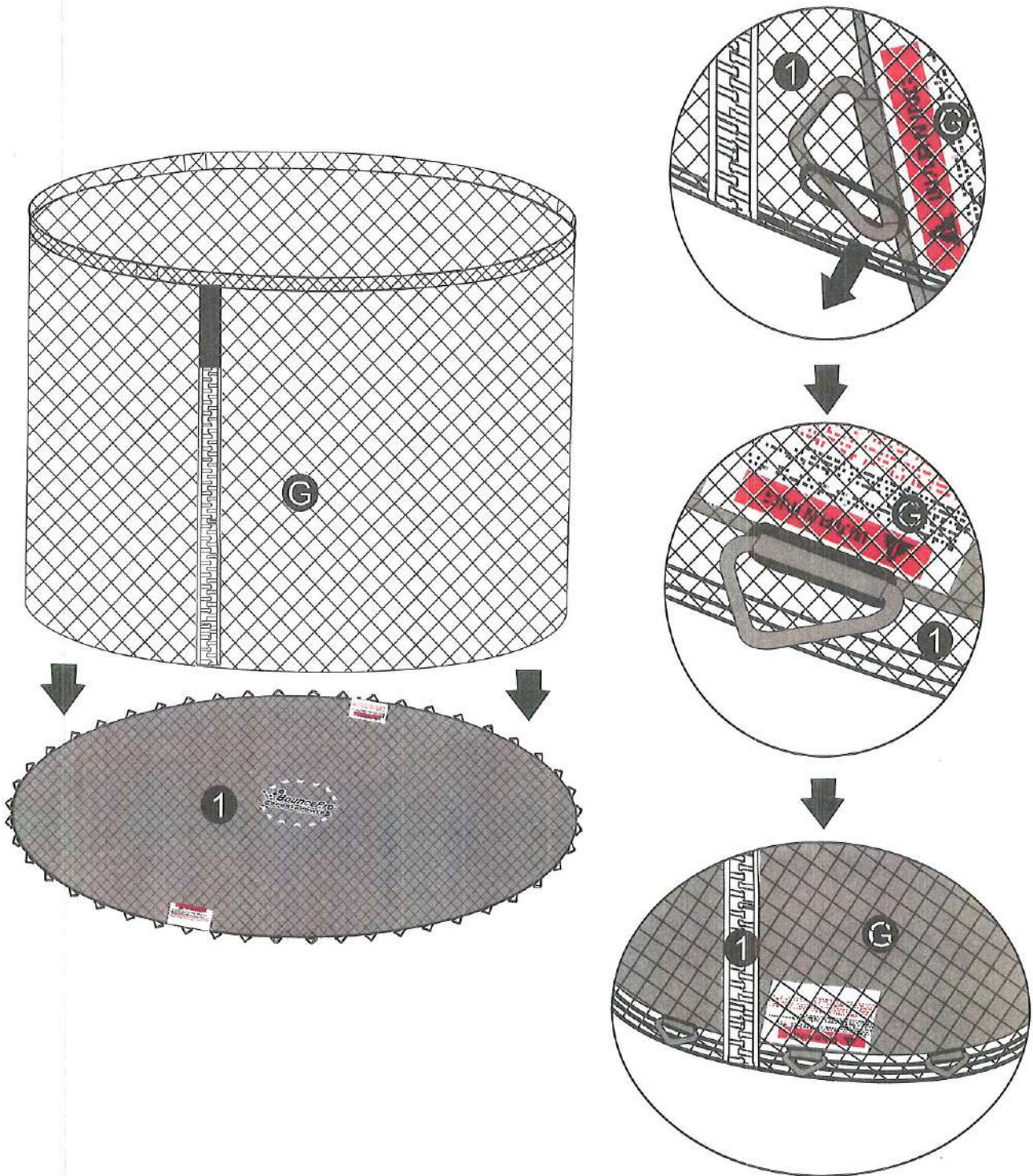

STEP 5- Spring Assembly

Place the mat, together with enclosure, flat on the ground in the center of the trampoline frame. Starting with point 1 as shown below, attach the springs by attaching one end into the triangle ring on the mat and then pulling the other end with the spring loading tool underhand. Make sure the hook is securely latched into the corresponding hole on the frame.

There are a total of 42 springs. For even distribution of spring tension and ease of assembly, the springs should be installed on opposite sides of the mat in an alternating manner, i.e. 1, then 22, followed by 12 and 33 as shown below.

IMPORTANT NOTE: Before you begin to assemble the springs, make sure to position the enclosure zipper midpoint between two leg supports to avoid obstruction when entering the trampoline.



Wear heavy gloves to protect your hands from pinching and eye goggles to avoid injuries to the eyes during assembly.

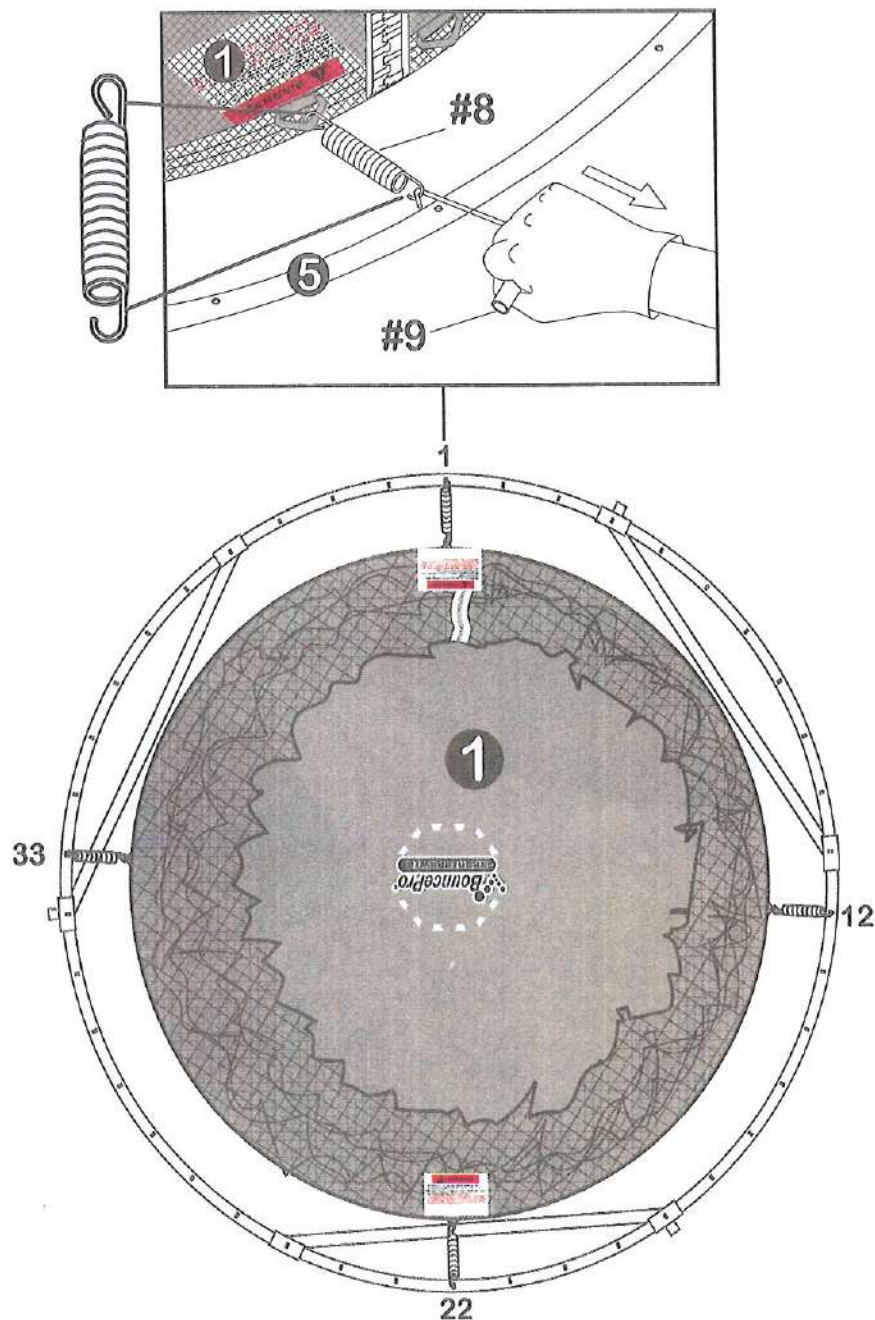

STEP 6

Continue to attach springs in the same manner, ensuring even distribution of tension by attaching springs on the opposite sides of the mat/frame in an alternating manner, i.e. 6 then 27, 17 then 38 as shown below.

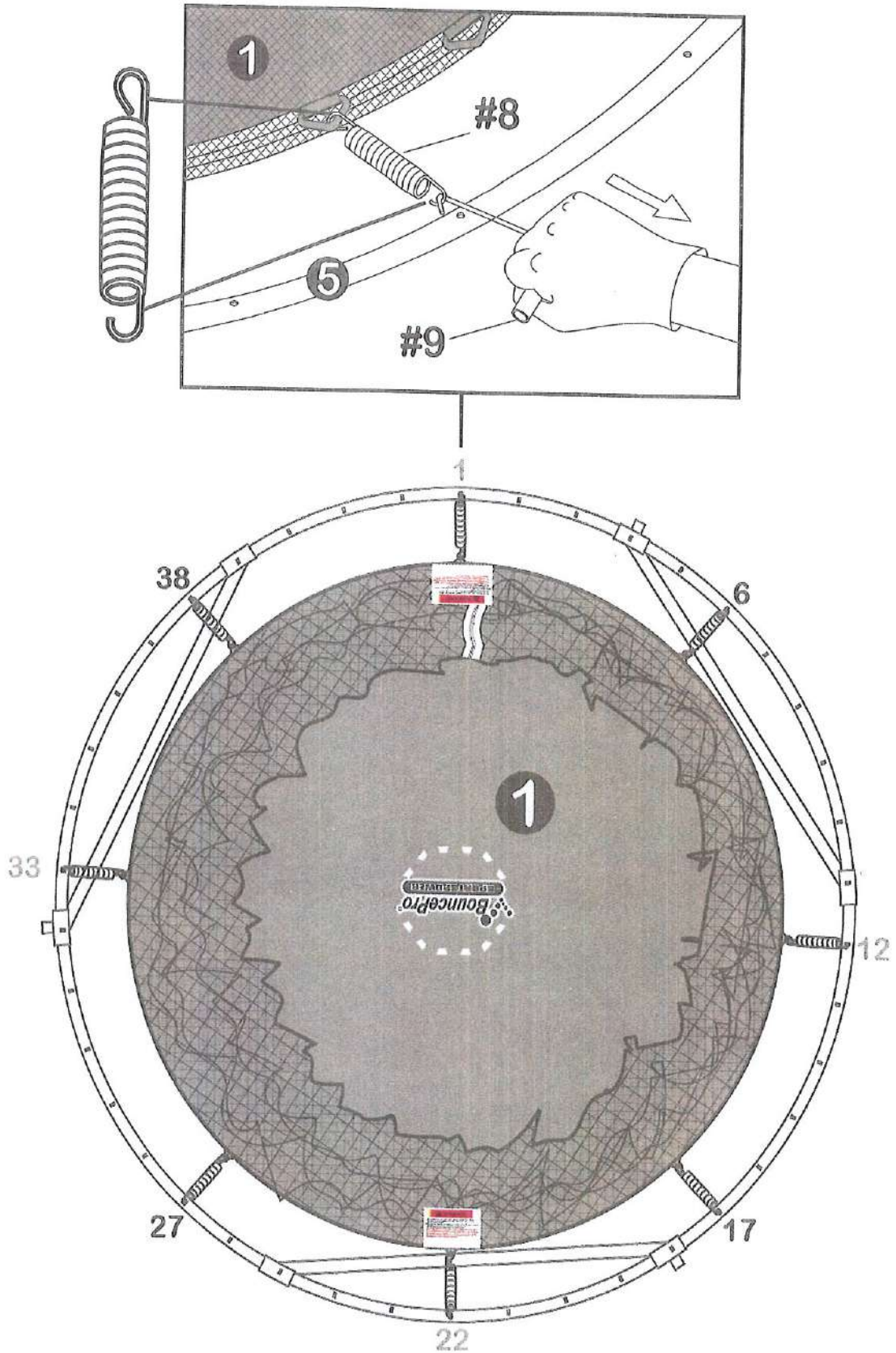

STEP 7

Continue to attach springs in the same manner, ensuring even distribution of tension by attaching springs on the opposite sides of the mat/frame in an alternating manner, i.e. 4 then 25, 9 then 30, 15 then 36, 19 then 41 as shown below.

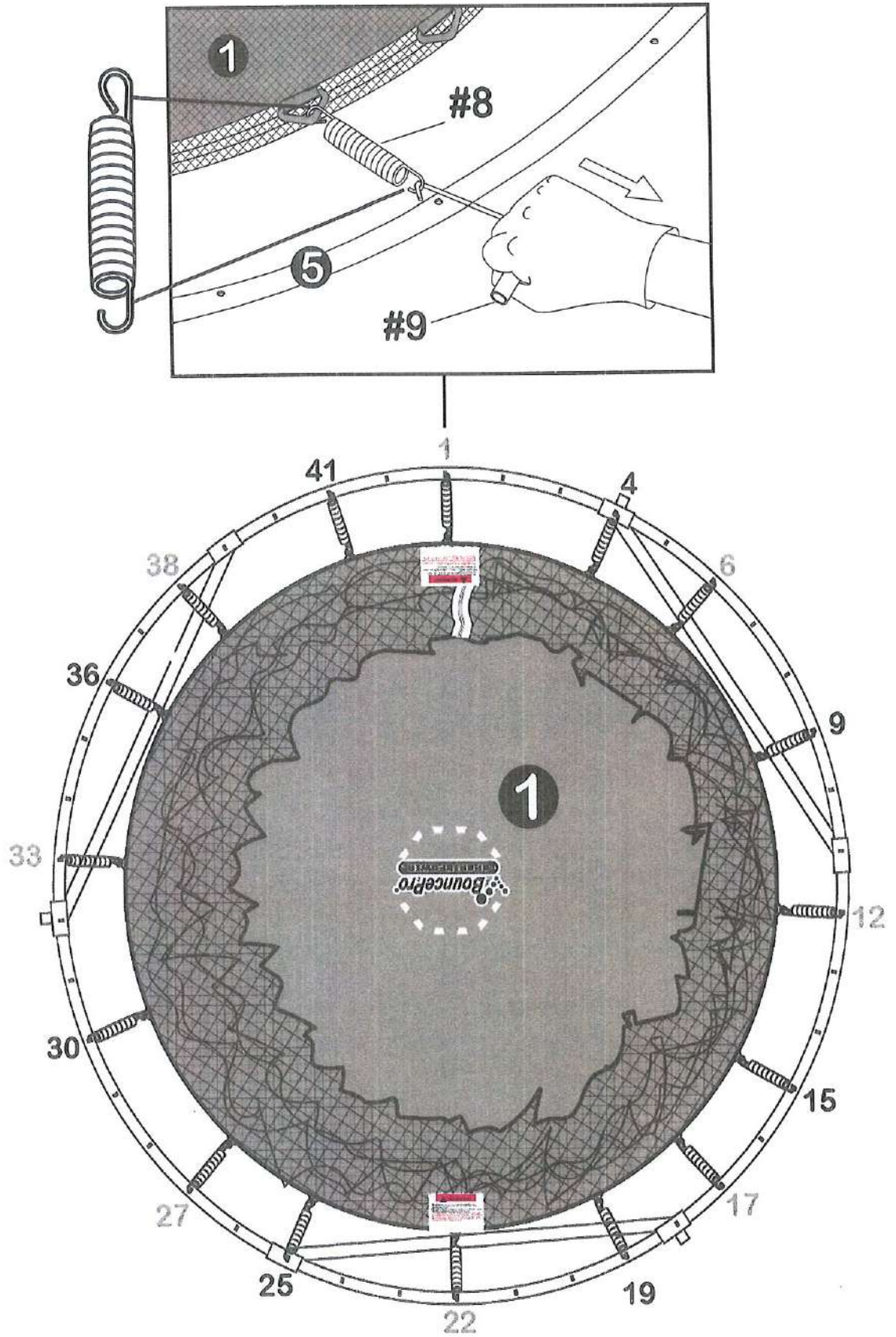

STEP 8

Continue to attach the remaining springs in the same manner as the previous step, i.e. the springs must be placed on opposite sides of the mat in an alternating manner to ensure even distribution of tension. The completed trampoline should look as shown below.

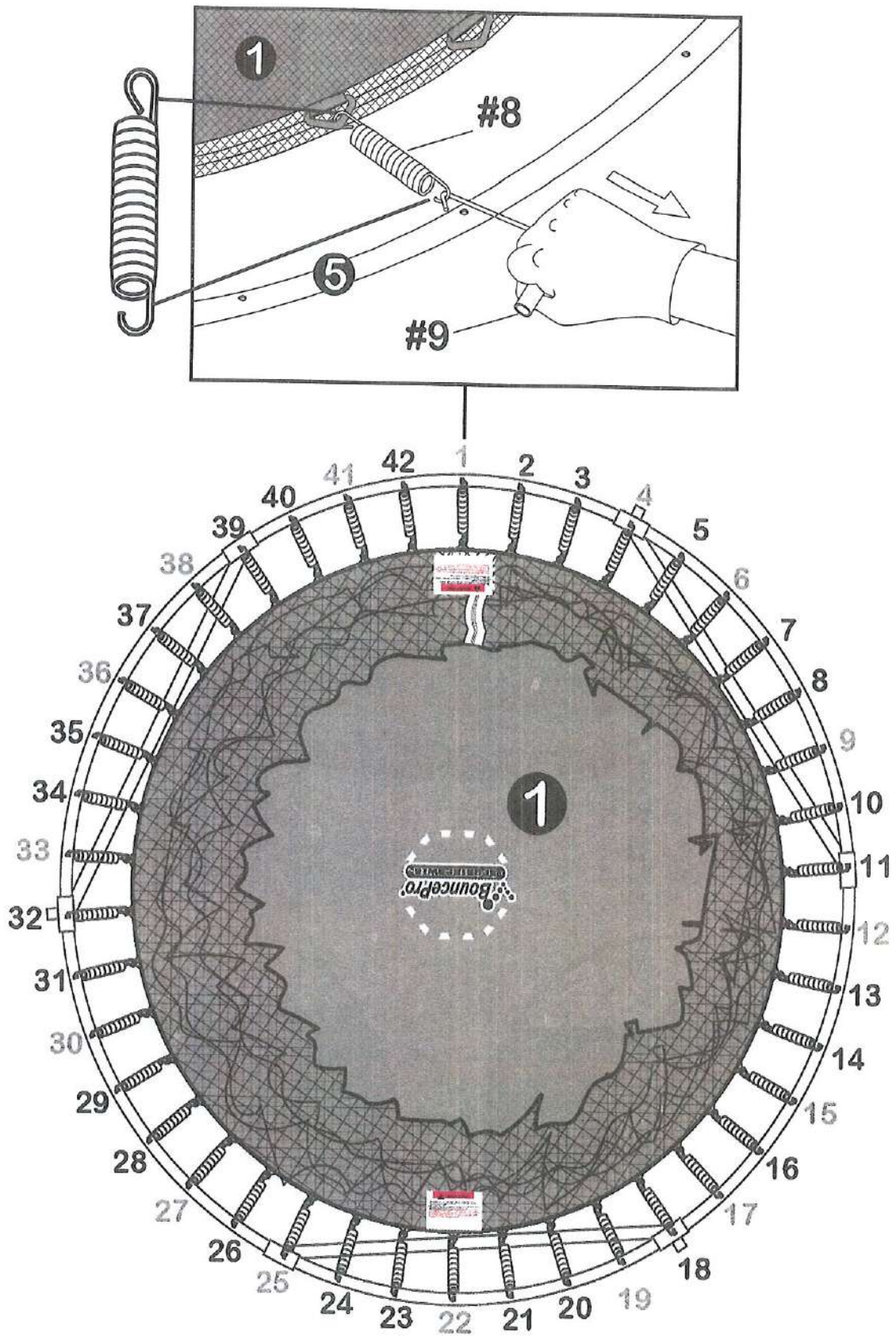

STEP 9

Place Frame Pad (# 2) onto the trampoline. Make sure all metal frame parts and springs are covered. Tie the outer straps on the frame pad to the leg frames and the inner straps to the triangle rings on the mat as shown.

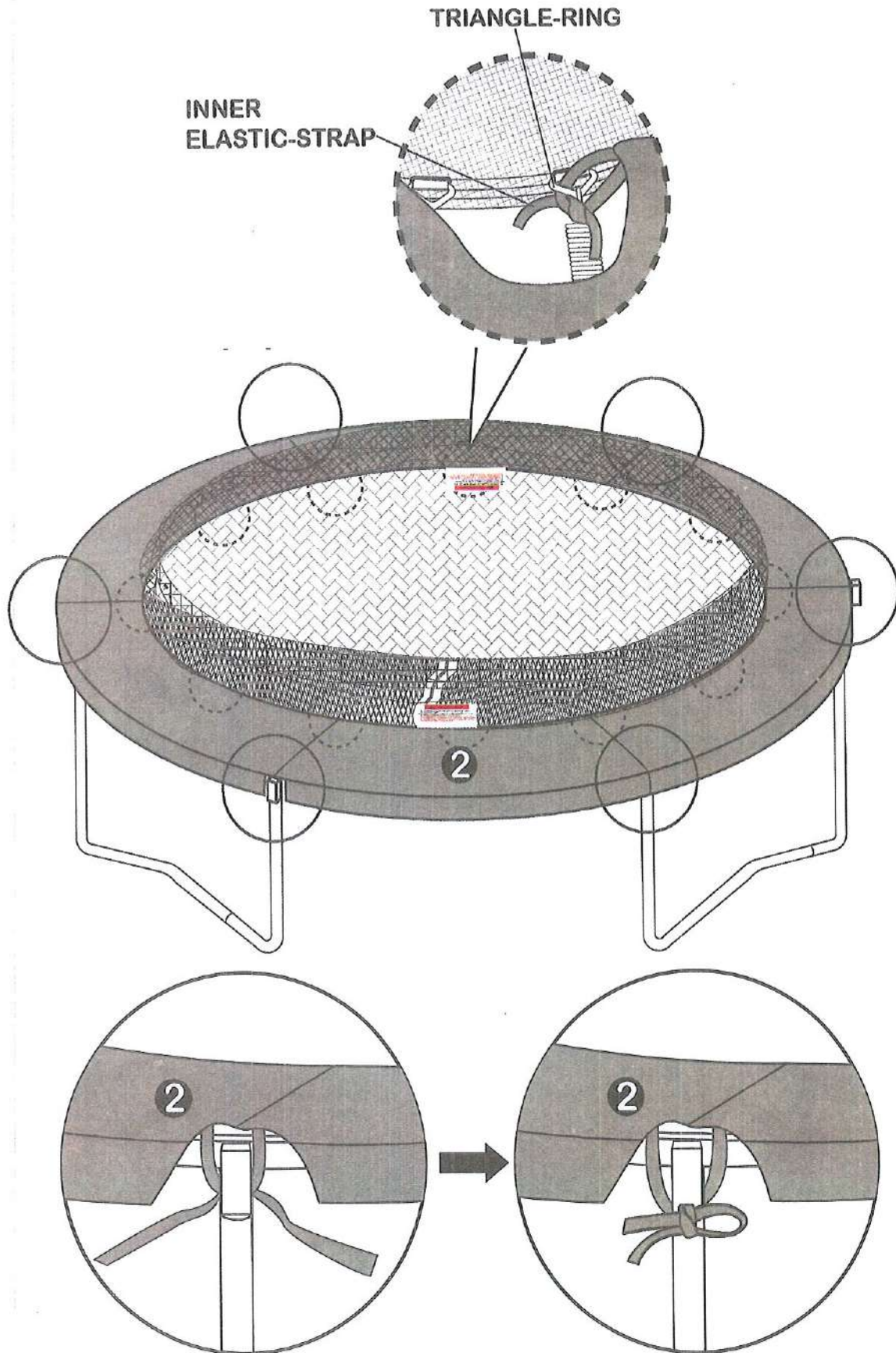

STEP 10

Insert Part B into the sockets of Part 4 and attach Part F to the base.

IMPORTANT NOTE: make sure the holes at the top of Part B are facing outward.

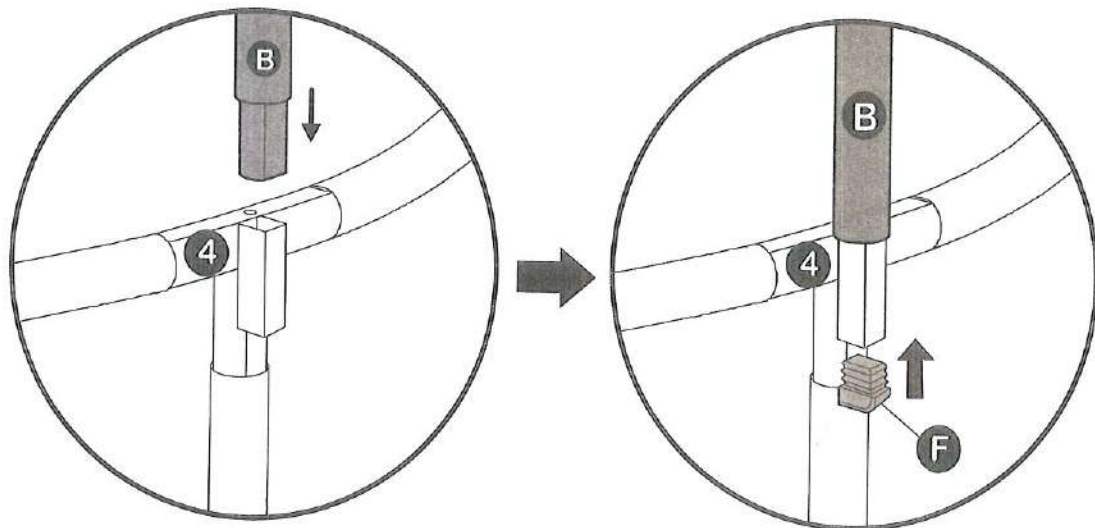
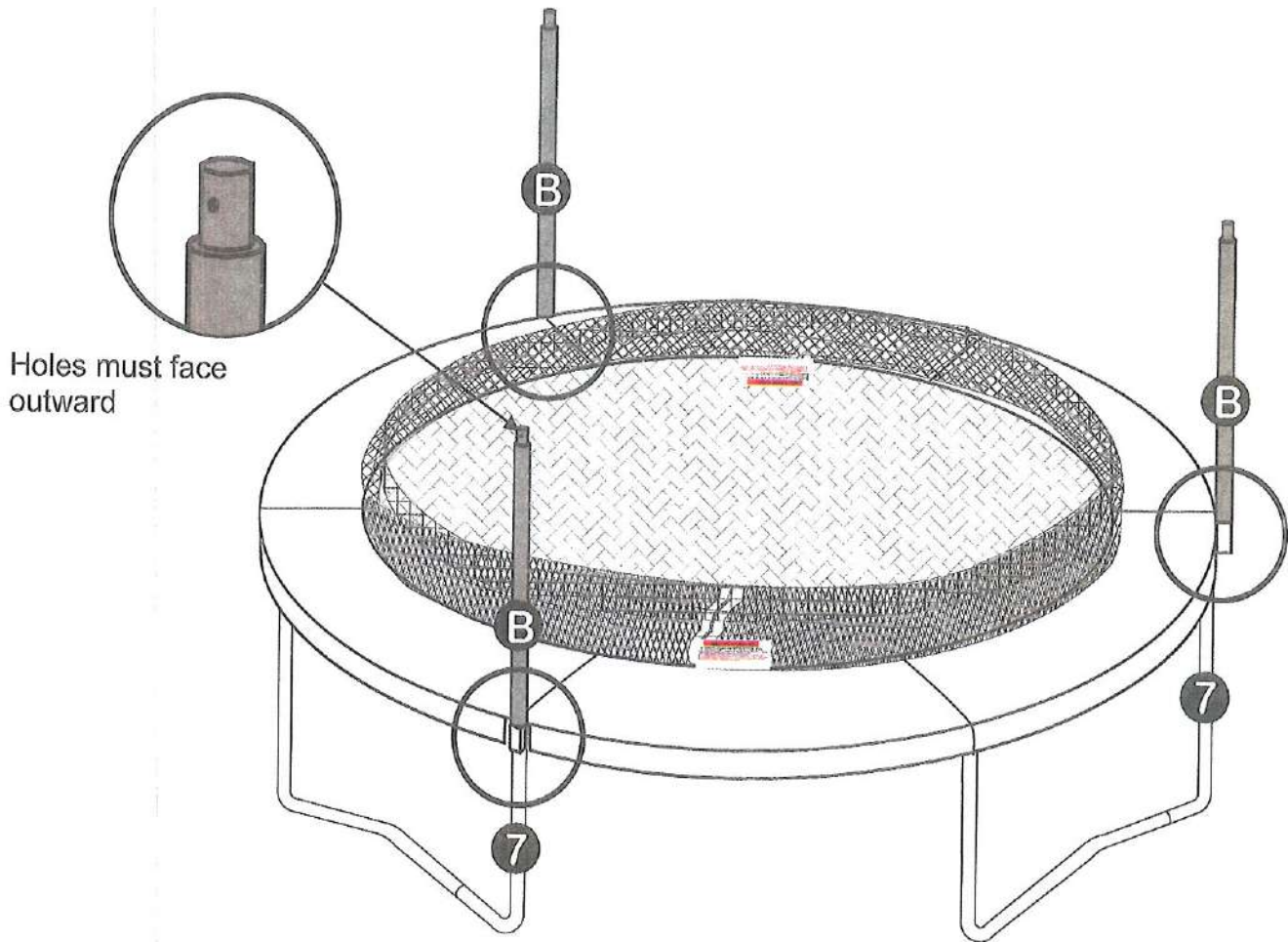

STEP 11 Connect C1 with C2 and insert it through the sleeve at the top of the enclosure net.

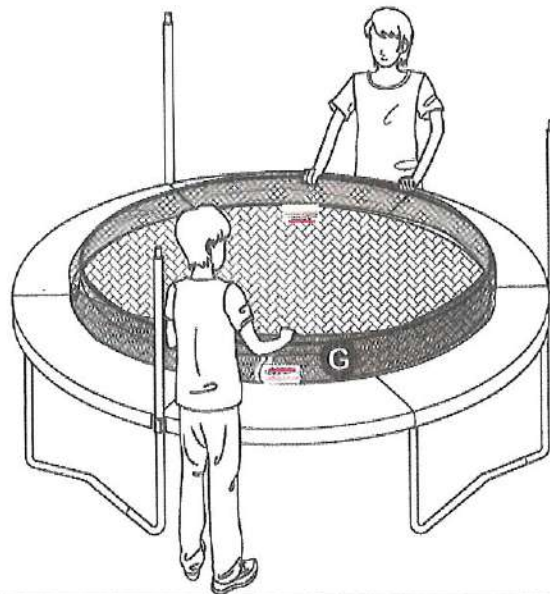
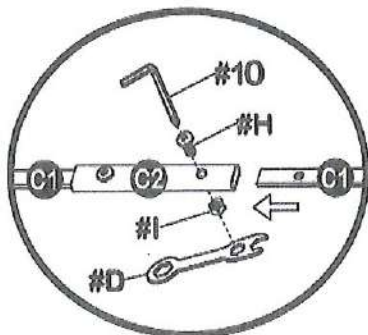
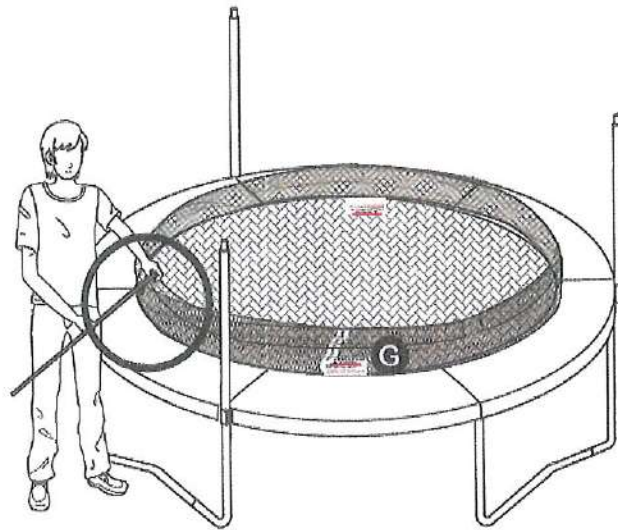
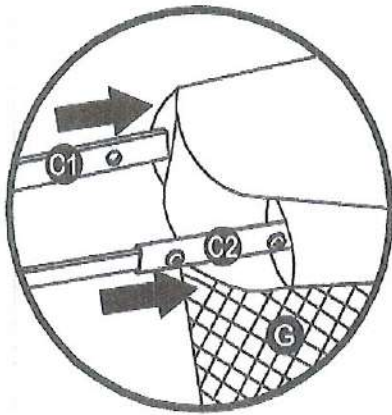
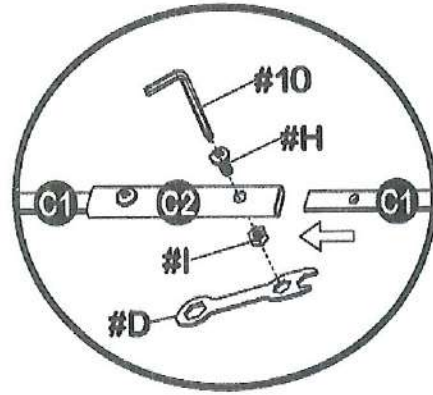
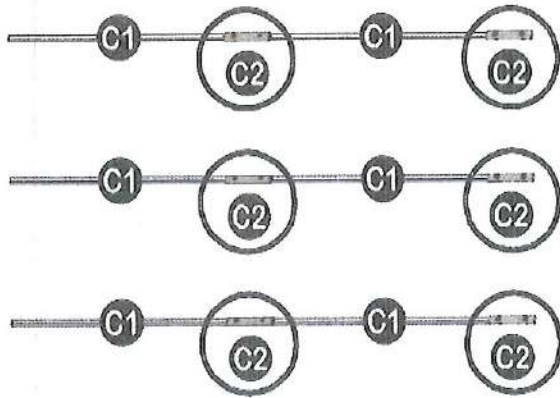

STEP 12

Attach Part J to Part A and secure with #E, then lock the plastic cap into the enclosure steel frame as shown.

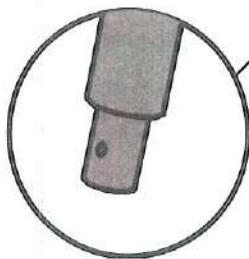
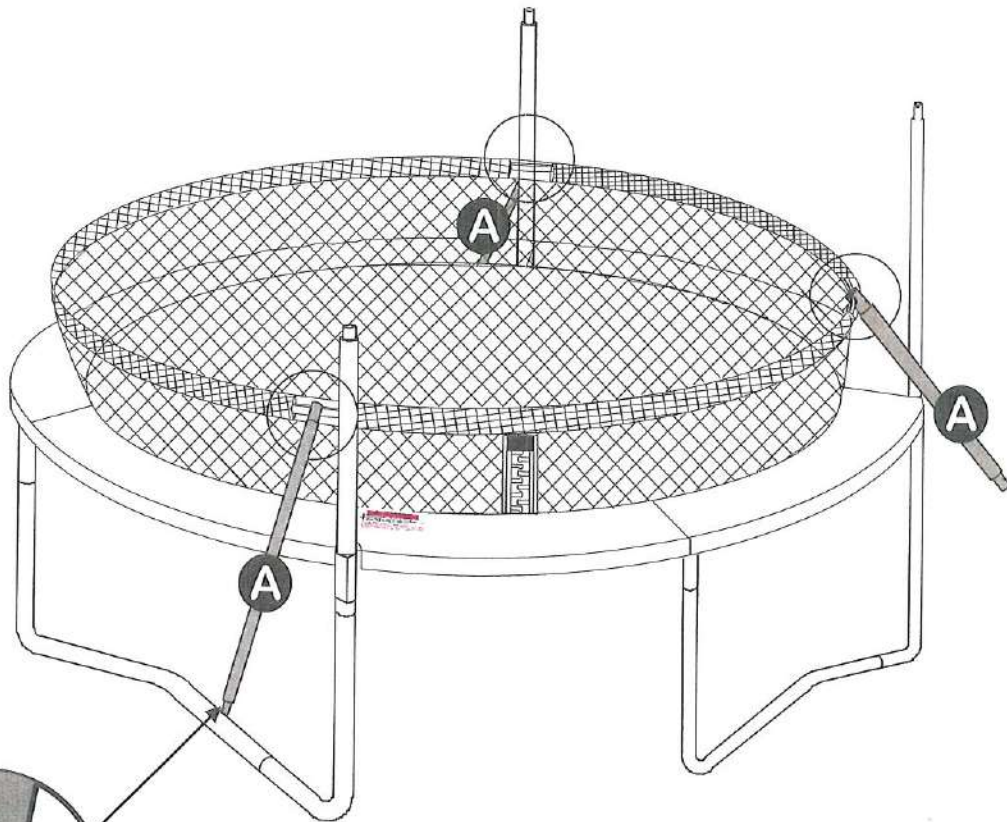
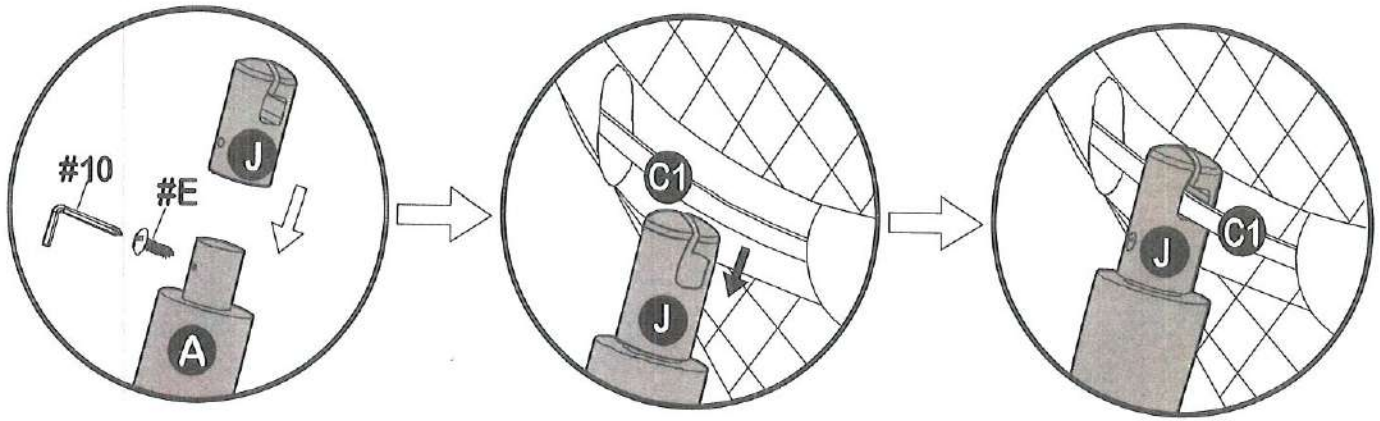

Holes must face outward

STEP 13

Connect Parts A and B and secure with #E.

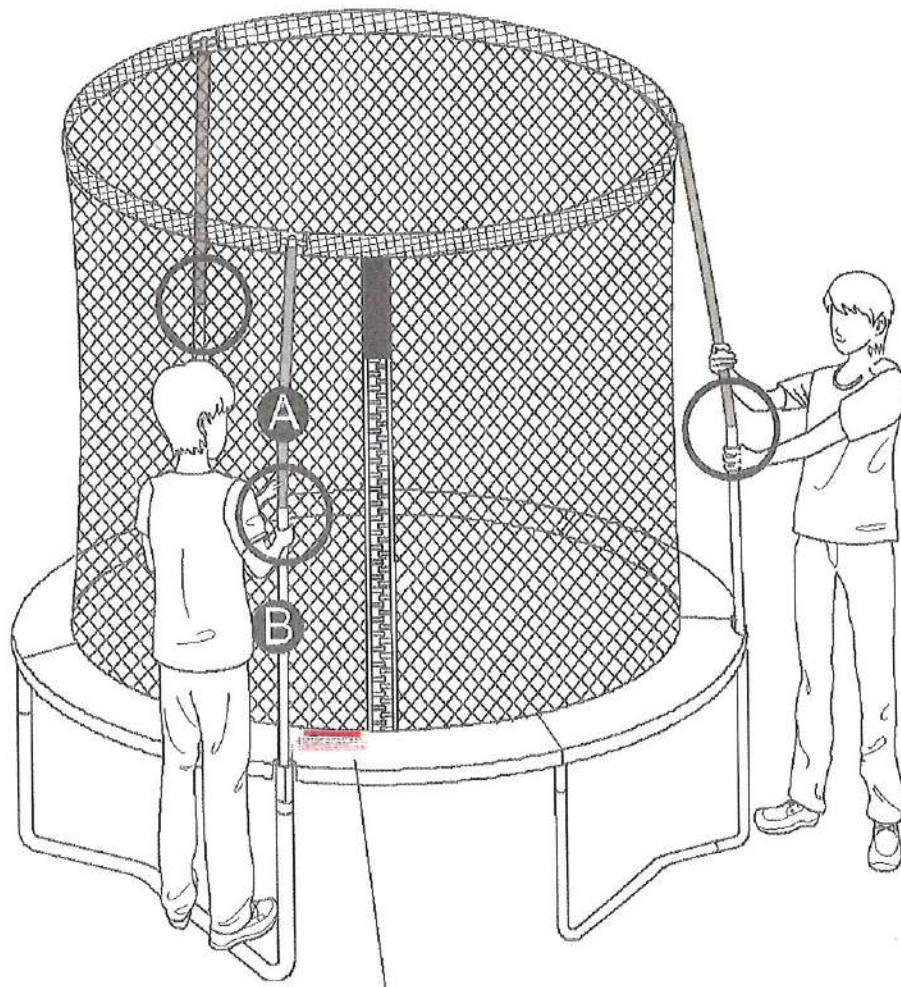
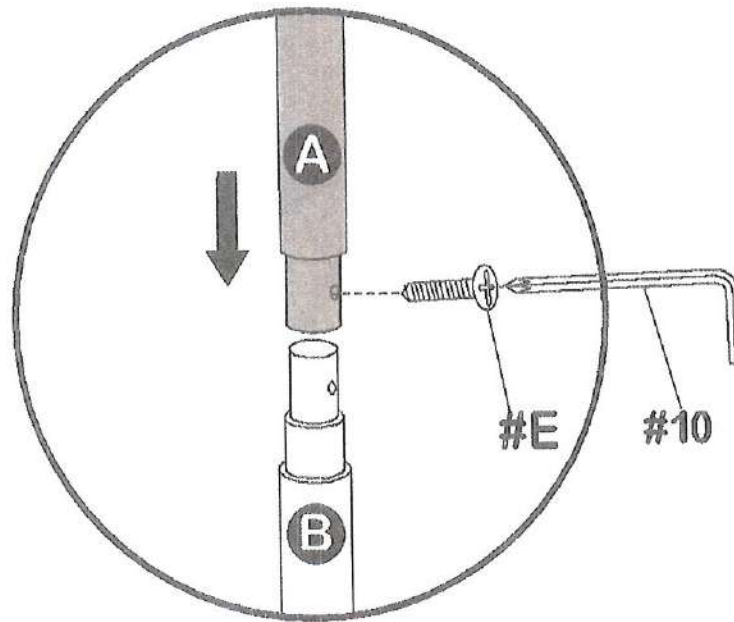

Warning label

STEP 14

Attach Safety Instruction Placard #K to the netting and #11 to the trampoline.

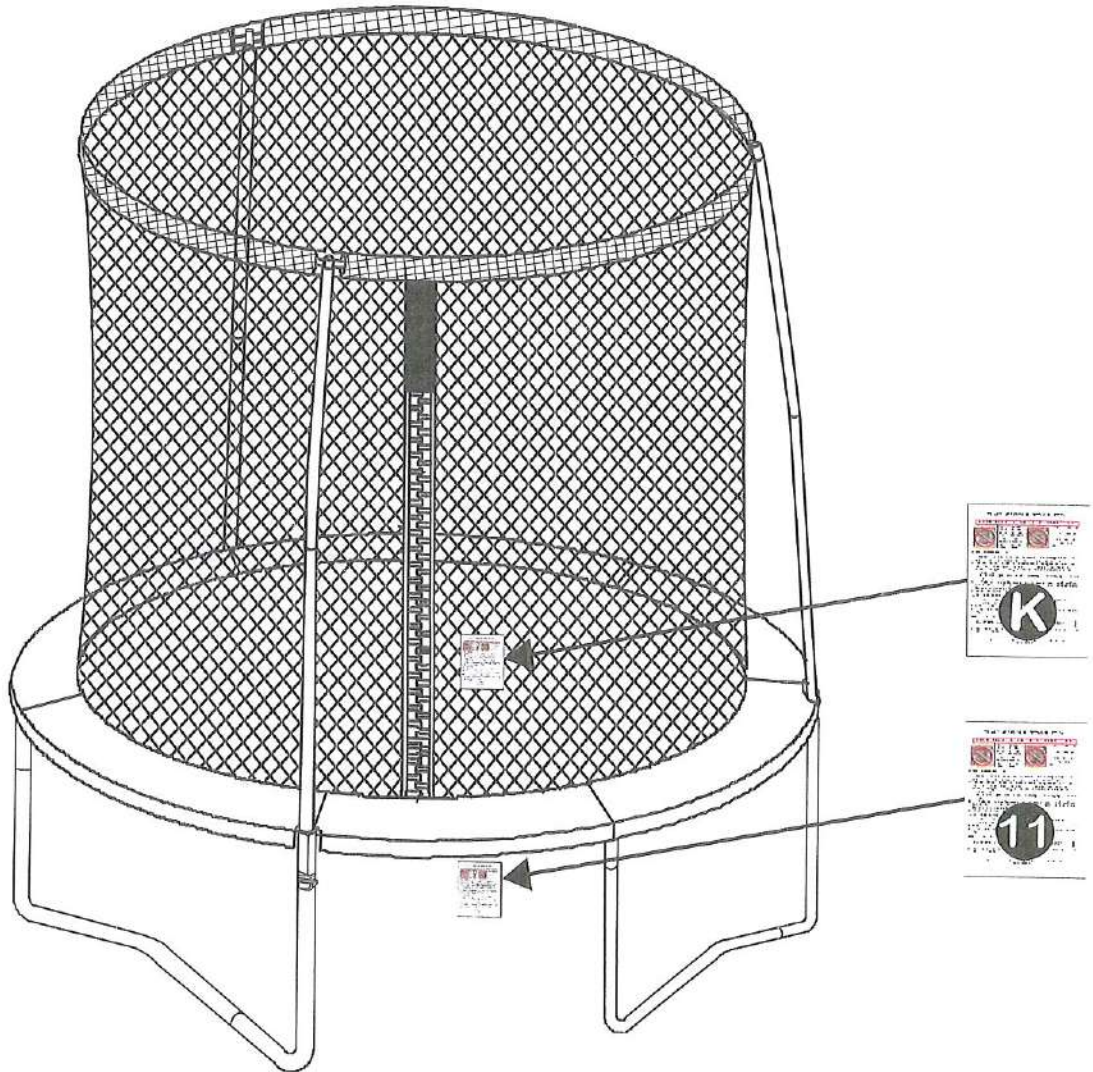

IMPORTANT

Once you have finished the assembly of the trampoline, go back over all of the nuts and bolts and properly tighten all of them before using.

Read this entire manual and make sure all jumpers completely understand all of the safety rules printed in the manual and on the various warning signs. Instruct all jumpers in the basic bounces described in the manual.

CARE AND MAINTENANCE AND USE INSTRUCTIONS MUST BE READ CAREFULLY BEFORE USING THE TRAMPOLINE. ADULT SUPERVISION IS REQUIRED AT ALL TIMES.

Disassembly of the Trampoline and Enclosure

If you need to disassemble the trampoline, please follow the assembly instructions in reverse and take special care to retain all parts. Retain the original packaging for transport purposes.

Moving the Trampoline and Enclosure

To move the trampoline, it is recommended for the trampoline to be disassembled and then reassembled in the new location. However, if you need to move the trampoline a short distance for any reason, you must use duct tape or heavy industry tape to tape all leg joints together. To move the trampoline requires two or more people to lift the trampoline from contact with the ground. Do not drag the trampoline along the ground. The trampoline must be kept steady and horizontal to the ground during the move. Failure to follow these instructions may result in the leg support coming loose which may cause serious injury or death.

WARNING

DO NOT USE THE TRAMPOLINE WHEN THE ENCLOSURE IS REMOVED.

Do not make changes or add attachments to the trampoline that are not authorized genuine Sportspower parts. The user must carry out changes to the trampoline (e.g. the addition of an attachment) according to the instructions of the manufacturer, particularly those attachments which include instructions on their assembly, necessary measurements and the correct fastening (e.g. enclosures, climbing assistance).

Care and Maintenance



Failure to follow these instructions to ensure proper operational condition of your trampoline may lead to serious injury or death.

WARNING

- The springs, trampoline legs and enclosure netting must be inspected prior to every use. The legs should be locked securely into place, all the springs attached to the frame and there should be no tears in the enclosure netting. If any part becomes damaged or worn, please stop using the trampoline immediately until this part is replaced with authorized Sportspower parts.
- If you see any signs of stretched or damaged springs, do not use the trampoline until replacement springs are properly installed. Please contact our customer service representatives to order original Sportspower replacement parts.
- Please do not use unauthorized Sportspower parts to assemble the trampoline. This may damage the integrity of the product and can cause injuries during use.
- To move the trampoline, it is recommended for the trampoline to be disassembled and then reassembled in the new location. However, if you need to move the trampoline a short distance for any reason, you must use duct tape or heavy industry tape to tape all leg joints together. To move the trampoline requires two or more people to lift the trampoline from contact with the ground. Do not drag the trampoline along the ground. The trampoline must be kept steady and horizontal to the ground during the move. Failure to follow these instructions may result in the leg support coming loose which may cause serious injury or death.
- The trampoline and enclosure must be stored away during harsh weather conditions including extreme wind, heat and freezing temperatures.
- Always properly store away the trampoline and enclosure when not in use and secure from any unauthorized use.
- Inspect the trampoline before each use and replace any worn, defective or missing parts. The following conditions could represent potential hazards:
 - Missing, improperly positioned or unsecured enclosure support system, frame padding and pole caps
 - Punctures, frays, tears or holes in the trampoline mat or enclosure support system or frame padding
 - Deterioration in the stitching or fabric of the mat, enclosure netting or frame padding
 - Ruptured or loose springs
 - Bent or broken support system (frame)
 - Sagging trampoline mat and/or sagging enclosure netting
 - Sharp protrusions on the support (frame) or suspension system

Proper Use Instructions



Read and understand the use instructions in this manual prior to using this product. Failure to do so can result in serious injury or death.

Responsibilities of the user

The key here is to stay in control of your jumps. DO NOT move onto more complicated, more difficult maneuvers until you have mastered the basic, fundamental bounce. Read, understand, and practice all precautions and warnings prior to using the trampoline. A controlled jump is when you land and take off from the same location. For additional tips and instructions, contact a certified trampoline instructor.

Supervisor's or owner's role in preventing injuries

It is the responsibility of the supervisor(s) of the trampoline users to provide knowledgeable and mature supervision. They need to know and enforce all the rules and warnings set forth in this manual in order to minimize the likelihood of accidents and injuries and to inform users of these rules. During the periods of time when supervision is unavailable or inadequate, the trampoline should be disassembled and stored in a secure place to prevent unauthorized use. The supervisor is also responsible to ensure that the safety placard is placed on the trampoline and that the jumpers are informed of these warnings and instructions.

DANGER

All jumpers need to be supervised, regardless of skill level or age.

- DO NOT attempt or allow somersaults. Landing on the head or neck can cause serious injury, paralysis or death, even when landing in the middle of the mat.
- Do not allow more than one person on the trampoline. Use by more than one person at the same time can result in serious injuries.
- Trampolines over 20 inches (51 cm) tall should not be used by children under six (6) years of age.
- Wear clothing free of drawstrings, hooks, loops or anything that could get caught while using the trampoline/enclosure and result in entanglement or strangulation, or both.
- Climb on and off the trampoline. It is a dangerous practice to jump from the trampoline to the floor or ground when dismounting, or to jump onto the trampoline when mounting. Do not use the trampoline as a springboard to other objects.
- Keep enclosure tightly fastened to the trampoline in accordance with the manufacturer's instructions. Failure to properly assemble and maintain a tight, secure trampoline/enclosure boundary may result in serious injury, strangulation or death.
- Completely close the opening of the enclosure before jumping. Close the opening of the enclosure after using the trampoline.
- Do not use the trampoline while under the influence of alcohol or drugs.
- Do not attempt to jump over the enclosure barrier.
- Do not intentionally rebound off the enclosure barrier.



Read and understand the use instructions in this manual prior to using this product. Failure to do so can result in serious injury or death.

WARNING

- Read all instructions before using the trampoline. Warnings and instructions for the care, maintenance and use of this trampoline are included to promote proper and enjoyable use of this equipment.
- Inspect the trampoline before each use. Make sure the frame padding, enclosure and the enclosure support (frame) padding is correctly and securely positioned. Replace any worn, defective or missing parts before using.
- Use trampoline only with mature, knowledgeable supervision.
- Check for loose cords and gaps. Users may become entangled in or strangled by loose cords or in gaps between trampoline and enclosure.
- Use trampoline only when the surface of the mat is dry. Wind or air movement should be calm to gentle. The trampoline must not be used in gusty or severe winds.
- Keep objects away which could interfere with the jumper. Maintain a clear area under, above, and around the trampoline.
- Do not attempt to crawl under the barrier.
- Do not hang from, kick, cut or climb on the barrier.
- Do not attach anything to the barrier that is not a manufacturer-approved accessory or part of the enclosure system.
- Enter and exit the enclosure only at the enclosure door.
- Learn fundamental bounces and body positions thoroughly before trying more advanced skills. A variety of trampoline activities can be carried out by performing the basic fundamentals in various series and combinations, performing one fundamental after another, with or without feet bounces between them.
- Stop bounce by flexing knees as feet come into contact with the trampoline mat. Learn this skill before attempting others.
- Avoid bouncing too high. Stay low until bounce control and repeated landing in the center of the trampoline can be accomplished. Control is more important than height while keeping the head erect, focus eyes on the trampoline toward the perimeter. This will help control the bounce.
- Avoid bouncing when tired. Keep turns short.
- Limit the time of continuous usage. Make regular stops. Do not jump when tired.
- Properly secure the trampoline when not in use. Protect it against unauthorized use. If a trampoline ladder is used, the supervisor should remove it from the trampoline when leaving the area to prevent unsupervised access by children under six (6) years of age.
- For information concerning skill training, contact a certified trampoline instructor.
- For additional information concerning the trampoline equipment, contact the manufacturer.
- Warning. The trampoline shall be assembled by an adult in accordance with the assembly instructions and thereafter checked before the first use.
- Warning. Empty pockets and hands before jumping.
- Warning. Do not exit by a jump.

Learning the fundamental trampoline skills

The following lessons are suggested for you to learn basic steps and bounces. Before using the trampoline, you should read and understand all warnings. A complete discussion and demonstration of body mechanics and trampoline guidelines should occur between the supervisor and student as well. The bounces are diagrammed on the following page.

Lesson 1

- A. Mounting and Dismounting – Demonstration of proper techniques
- B. The Basic Bounce – Demonstration and practice
- C. Braking (Check the Bounce – Demonstration) and practice. Learn to brake on command
- D. Hands and Knees Bounce – Demonstration and practice. Stress should be on four-point landing and alignment

Lesson 2

- A. Review and practice of techniques learned in Lesson 1
- B. Knee Bounce – Demonstration and practice. Learn the basic down to knee and back up before trying half twist to left and right
- C. Seat Bounce – Demonstration and practice. Learn basic seat bounce then add a knee bounce, hands and knees repeat

Lesson 3

- A. Review and practice skills and techniques learned in previous lessons
- B. Front Drop – To avoid mat burns and teach the front bounce position, all students should be requested to assume the prone position (face down on the ground) while the instructor checks for faulty positions that could cause injury
- C. Start with a Hands and Knees bounce and then extend body into prone position and on the mat and return to feet
- D. Practice Routine – Hands and Knees Bounce, Front Bounce, return to feet, Seat Bounce, return to feet, Seat Bounce, return to feet

Lesson 4

- A. Review and practice skills and techniques learned in previous lessons
- B. Half – Turn
 - i. Start from front drop position and as you make contact with mat, push off with arms in either the right or left direction and turn head and shoulders in same direction
 - ii. During turn, be sure to keep back parallel to mat and head up
 - iii. After completing turn, land in the Front Drop position

After completing this lesson, the student now has a basic foundation of trampoline bounces. Jumpers should be encouraged to try and develop their own routines with the emphasis on control and form.

A game that can be played in order to encourage students to try developing routines is “BOUNCE”. In this game, players count off from 1 to X. Player one starts with a maneuver. Player two has to do Player one’s maneuver and add on another. Each player must do the routine properly in the correct sequence. The first person to miss receives the letter “B”. This continues until someone spells out the word “BOUNCE”. The last remaining contestant is deemed the winner! Even when playing this game, it is important to perform your routines under control and not try difficult or highly skilled bounces that you have not yet mastered.

A certified trampoline instructor should be contacted to further develop your trampoline skills.

BASIC TRAMPOLINE BOUNCES

THE BASIC BOUNCE

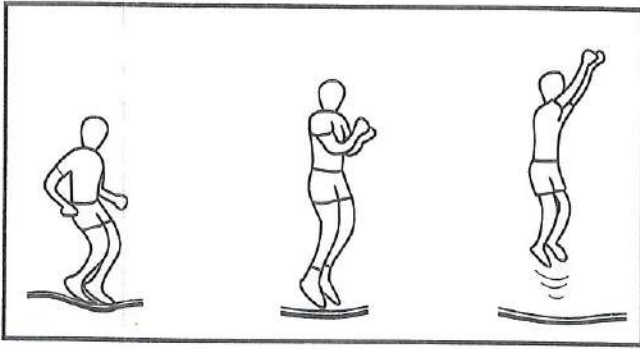

1. Start from the standing position, with your feet having shoulder width apart and with head up and eyes on mat
2. Swing arms forward and up in a circular motion
3. Bring feet together while in mid-air and point toes downwards.
4. Keep the feet shoulder width apart when landing on mat

THE KNEE BOUNCE

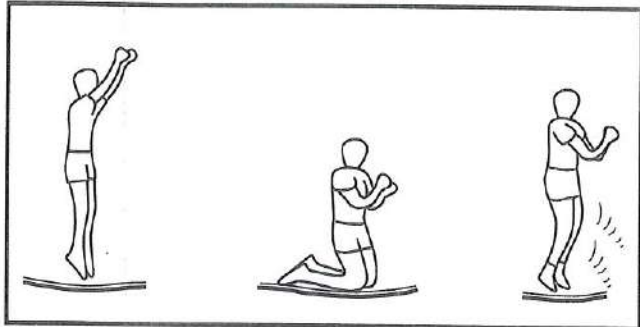

1. Start with the basic bounce and keep it low
2. Land on knees while keeping your back straight and body erect while using your arms to maintain balance
3. Bounce back to basic bounce position by swinging arms up

THE SEAT BOUNCE

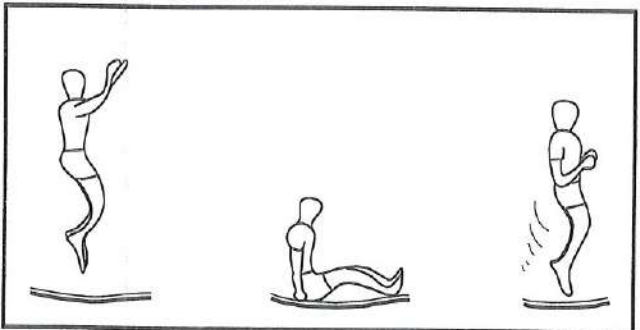

1. Land in a flat sitting position
2. Place hands on mat besides hips, but do not lock your elbow
3. Return to erect position by pushing with hands

THE 180 DEGREE BOUNCE

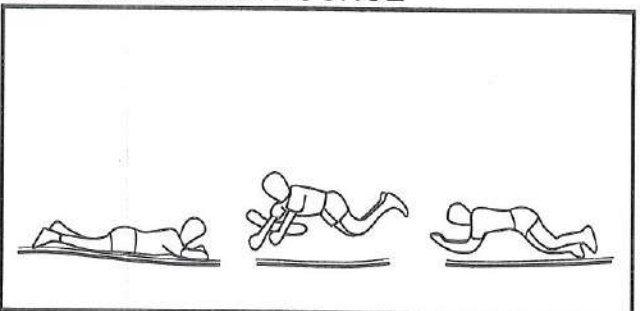

1. Start with the Front Bounce position
2. Push off with left or right hands and arms (depending on which way you wish to turn)
3. Maintain head and shoulders in the same direction while keeping your back parallel to the mat and your head up
4. Land in the Prone position and return to standing position

Product Warranty

Sportspower Ltd warrants its products to be free from defects in material and workmanship under normal use and service conditions for ninety (90) days after the date of purchase. The steel frame on trampolines is warranted for two (2) years after the date of purchase.

All warranty coverage extends only to the original purchaser of the product and is not assignable or transferable. The original store or online purchase receipt must be kept as proof of purchase in order for the warranty to be valid. These documents must be presented in the event of making a warranty claim.

During the warranty period, Sportspower will provide repair or replacement of defective equipment or parts thereof covered by the warranty. Any handling, transportation, delivery and other incidental charges in respect of the servicing of the equipment shall be borne by the Purchaser. If the product includes a number of accessories, only the defective part or accessory will be replaced.

The warranty will become void if any defects or damages are associated with the use of unauthorised replacement parts. All replacement parts must be obtained from Sportspower authorised agents.

All decisions made by Sportspower made in respect of the servicing of the equipment (including repairs, replacements or issues relating to defects of workmanship or materials) shall be conclusive and the Purchaser agrees to be bound by such decisions. Any defective equipment or part thereof replaced shall become the property of Sportspower.

In the event of a product or accessory being replaced during the guarantee, the guarantee on the replacement will expire at the original date, i.e. 90 days from the original purchase date.

This warranty excludes defects caused by the product not being used in accordance with instructions, accidental damage, misuse or being tampered with by unauthorised persons.

The Sportspower Limited Warranty does not cover:

- a) Products used for commercial or rental purposes.
- b) Loss or damage to product due to:
 - i. Abuse, repairs and/or tampering by any person other than the authorised personnel of Sportspower
 - ii. Negligence and/or misuse (including foreign objects, accidents, improper storage, exposure to sun/moisture, excessive temperature, sand, dust, dirt, other pollution or other environmental conditions and failure to follow precautions or proper operating instructions stated in the User's Manual such as improper installations)
 - iii. Fire, flood, lightning strike, wind storm or other acts of Nature.
 - iv. Freight or improper transport damages, and
 - v. Improper usage (including use by underage, overweight or excessive number of users permitted as stated in the User's Manual).
- c) Defects, damages or accidents due to the malfunction, connection to or use of non- Sportspower or unauthorized parts. In such event, Sportspower reserves the right to cancel the Limited Warranty coverage immediately.

To the extent allowed by the applicable local law, the remedies in the Limited Warranty are the Purchaser's sole and exclusive remedies.

SPORTSPOWER IS NOT RESPONSIBLE OR LIABLE FOR INDIRECT, SPECIAL OR CONSEQUENTIAL DAMAGES ARISING OUT OF OR IN CONNECTION WITH THE USE OR PERFORMANCE OF THE PRODUCT OR OTHER DAMAGES WITH RESPECT TO ANY ECONOMIC LOSS, LOSS OF PROPERTY, LOSS OF REVENUE OR PROFITS, LOSS OF ENJOYMENT OR USE, COST OF REMOVAL, INSTALLATION OR OTHER CONSEQUENTIAL DAMAGES.

PLEASE NOTE: ANY REPAIRS OR REPLACEMENTS MUST BE MADE USING AUTHORIZED SPORTSPOWER PARTS IN ORDER FOR THIS WARRANTY TO BE VALID.

DO NOT RETURN PRODUCT TO THE STORE. PLEASE CONTACT OUR CUSTOMER SERVICE FOR PARTS OR ASSEMBLY INSTRUCTIONS. STORES ARE NOT EQUIPPED TO PROVIDE CUSTOMER SERVICE FOR THIS PRODUCT.

For Customer Service, please call 0330 0904 420 or email to

support@sportspower.biz

